



**EH1934**

## **INSTRUCTION MANUAL**



**20 Litre / Day Dehumidifier**



**Please keep this manual for further reference!**

**Thank you for selecting this Prem-i-air dehumidifier. Be sure to read this manual carefully before use.**

# 1. BEFORE YOU BEGIN





Please read the operating instructions carefully before using your dehumidifier for the first time.

## 1.1 PRODUCT DESCRIPTION

The dehumidifier is used to remove excessive moisture from the air. The resulting reduction in relative humidity protects buildings and their contents from the adverse effects of excess humidity.

The environmentally friendly R290 is used as the refrigerant. R290 has no damaging influence on the ozone layer (ODP), a negligible greenhouse effect (GWP) and is available worldwide. Because of its efficient energy properties, R290 is highly suitable as a coolant for this application. Special precautions must be taken into consideration due to the coolant's high flammability.

### SYMBOLS FROM THE UNIT AND USER MANUAL

 <b>warning</b>	This unit uses a flammable refrigerant. There is a risk of fire if refrigerant leaks and comes in contact with a spark or other ignition source.
	Read the USER MANUAL carefully before operation.
	Further information is available in the USER MANUAL, SERVICE MANUAL, and the like.
	Service personnel are required to carefully read the USER MANUAL and SERVICE MANUAL before operation.

## 1.2 THE FOLLOWING SHOULD ALWAYS BE OBSERVED FOR SAFETY

- This appliance can be used by children aged from 8 years and above and persons with reduced physical, sensory, or mental capabilities or lack of experience and knowledge if they have been given supervision or instruction concerning use of the appliance in a safe way and understand the hazards involved.
- Children shall not play with the appliance.
- Cleaning and user maintenance shall not be made by children without supervision.
- This unit is designed only for use with R-290(propane) gas as the designated refrigerant.
- The refrigerant loop is sealed. Only a qualified technician should attempt to service!
- Do not discharge the refrigerant into the atmosphere.
- R-290 (propane) is flammable and heavier than air. It collects first in low areas but can be circulated by the fans. If propane gas is present or even suspected, do not allow untrained

personnel to attempt to find the cause. The propane gas used in the unit has no odor. The lack of smell does not indicate a lack of escaped gas.

- If a leak is detected, immediately evacuate all persons from the area, ventilate the room and contact the fire brigade to advise them that a propane leak has occurred.
- Do not let any persons back into the room until the qualified service technician has arrived and that technician advises that it is safe to return.
- No open flames, cigarettes or other possible sources of ignition should be used inside or in the vicinity of the units.
- Component parts are designed for propane and non-incentive and non-sparking. Component parts shall only be replaced with identical parts.

**FAILURE TO ABIDE BY THIS WARNING COULD RESULT IN AN EXPLOSION, DEATH, INJURY AND PROPERTY DAMAGE**

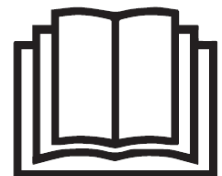

## 2. FOR YOUR SAFETY



Please read this manual carefully and fully understand before operating your dehumidifier.

### 2.1 OPERATING PRECAUTIONS

**WARNING-** to reduce the risk of fire, electric shock or injury to persons or property:

- If the supply cord is damaged, it must be replaced by the manufacturer or similarly qualified persons in order to avoid a hazard.
- The appliance shall be disconnected from its power source during maintenance.
- Always operate the unit from a power source of equal voltage, frequency and rating as indicated on the product identification plate.
- Always use a power outlet that is earthed.
- Unplug the power cord when cleaning or when not in use.
- Do not operate with wet hands. Prevent water from spilling onto the unit.
- Do not immerse or expose the unit to rain, moisture or any other liquid.

- Do not leave the unit running unattended. Do not tilt or turn over the unit.
- Do not unplug while the unit is operating, this may cause damage and unwanted wear.
- Do not unplug by pulling on the power cord.
- Do not use in bathrooms.
- Use only on firm flat surfaces and this unit is not intended for use in Caravans, boats or other unstable locations.
- Do not use an extension cord or an adapter plug.
- Do not put objects on the unit.
- Do not climb or sit on the unit.
- Do not insert fingers or other objects into the air outlet.
- Do not touch the air inlet or the aluminum fins of the unit as they have sharp edges.
- Do not operate the unit if it is dropped, damaged or showing signs of product malfunction.
- Do not clean the appliance with any chemicals.
- Ensure the unit is kept away from fire.
- Do not use where paint, petrol or other flammable liquids are stored.
- The unit shall be installed in accordance with national wiring regulations.
- Do not use means to accelerate the defrosting process or to clean, other than those recommended by the manufacture.
- The appliance shall be stored in a room without continuously operation sources (for example: open flames, an operating gas appliance or an operating electric heater).
- The appliance shall be stored so as to prevent mechanical damage from occurring.
- Do not piece or burn, even after use.
- Be aware that refrigerants may not contain an odor.
- Pipework shall be protected from physical damage and shall not be installed in an unventilated space, if that space is smaller than 4m<sup>2</sup>.
- Compliance with national gas regulations shall be observed.
- Keep any required ventilation openings clear of obstruction.
- Do Not use this appliance for other than its intended use.
- The appliance shall be stored in a well-ventilated area where the room size corresponds to the room area as specified for operation.



Any person who is involved with working on or breaking into a refrigerant circuit should hold a current valid certificate from an industry-accredited assessment authority, which authorizes their competence to handle refrigerants safely in accordance with an industry, recognized assessment specification.



Service shall only be performed as recommended by the equipment manufacturer. Maintenance and repair requiring the assistance of other skilled personnel shall be carried out under the supervision of the person competent in the use of flammable refrigerants.

If you don't understand something or need help, please contact the dealer services

## **2.2 SAFETY PRECAUTIONS ON SERVICING**

Please follow these warnings when to undertake the following when servicing a dehumidifier with R290.

### **2.2.1 Checks to the area**

Prior to beginning work on systems containing flammable refrigerants, safety checks are necessary to ensure that the risk of ignition is minimized. For repair to the refrigerating system, the following precautions shall be complied with prior to conducting work on the system.

### **2.2.2 Work procedure**

Work shall be undertaken under a controlled procedure so as to minimize the risk of a flammable gas or vapor being present while the work is being performed.

### **2.2.3 General work area**

All maintenance staff and others working in the local area shall be instructed on the nature of work being carried out. Work in confined spaces shall be avoided. The area around the workspace shall be sectioned off. Ensure that the conditions within the area have been made safe by control of flammable material.

### **2.2.4 Checking for presence of refrigerant**

The area shall be checked with an appropriate refrigerant detector prior to and during work, to ensure the technician is aware of potentially flammable atmospheres. Ensure that the leak detection equipment being used is suitable for use with flammable refrigerants, i.e. no sparking, adequately sealed or intrinsically safe.

### **2.2.5 Presence of fire extinguisher**

If any hot work is to be conducted on the refrigeration equipment or any associated parts, appropriate fire extinguishing equipment shall be available to hand. Have a dry powder or CO2 fire extinguisher adjacent to the charging area.

### **2.2.6 No ignition sources**

No person carrying out work in relation to a refrigeration system which involves exposing any pipe work that contains or has contained flammable refrigerant shall use any sources of ignition in such a manner that it may lead to the risk of fire or explosion. All possible ignition sources, including cigarette smoking, should be kept sufficiently far away from the site of installation, repairing, removing and disposal, during which flammable refrigerant can possibly be released to the surrounding space. Prior to work taking place, the area around the equipment is to be surveyed to make sure that there are no flammable hazards or ignition risks. "No Smoking" signs shall be displayed.

### **2.2.7 Ventilated area**

Ensure that the area is in the open or that it is adequately ventilated before breaking into the system or conducting any hot work. A degree of ventilation shall continue during the period that the work is carried out. The ventilation should safely disperse any released refrigerant and preferably expel it externally into the atmosphere.

### 2.2.8 Checks to the refrigeration equipment

Where electrical components are being changed, they shall be fit for the purpose and to the correct specification. At all times the manufacturer's maintenance and service guidelines shall be followed. If in doubt consult the manufacturer's technical department for assistance.

The following checks shall be applied to installations using flammable refrigerants:

- The charge size is in accordance with the room size within which the refrigerant containing parts are installed.
- The ventilation machinery and outlets are operating adequately and are not obstructed.
- If an indirect refrigerating circuit is being used, the secondary circuit shall be checked for the presence of refrigerant.
- Marking to the equipment continues to be visible and legible. Markings and signs that are illegible shall be corrected.
- refrigeration pipe or components are installed in a position where they are unlikely to be exposed to any substance which may corrode refrigerant containing components, unless the components are constructed of materials which are inherently resistant to being corroded or are suitably protected against being so corroded.

### 2.2.9 Checks to electrical devices

Repair and maintenance to electrical components shall include initial safety checks and component inspection procedures. If a fault exists that could compromise safety, then no electrical supply shall be connected to the circuit until it is satisfactorily dealt with. If the fault cannot be corrected immediately but it is necessary to continue operation, an adequate temporary solution shall be used. This shall be reported to the owner of the equipment, so all parties are advised.

Initial safety checks shall include:

- those capacitors are discharged: this shall be done in a safe manner to avoid possibility of sparking.
- that there no live electrical components and wiring are exposed while charging, recovering or purging the system.
- that there is continuity of earth bonding

## 3. PRODUCT OVERVIEW

### 3.1 PRODUCT VIEW

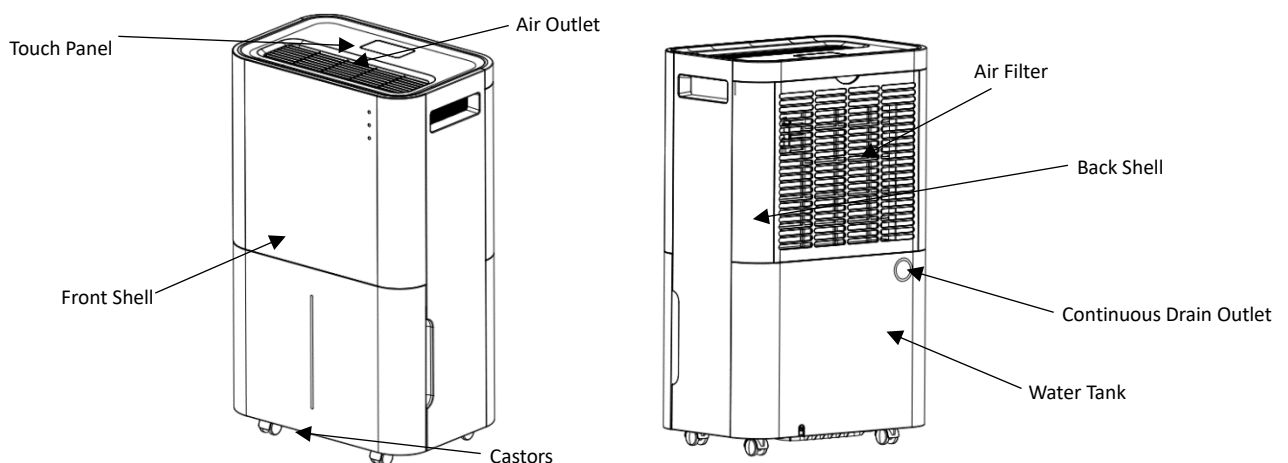

## 4. INSTALLATION

### 4.1 LOCATION

1. Place the unit on a firm, level surface in an area with at least 30cm of free space around it to allow for proper air circulation.
2. Never install the unit where it could be subject to :
  - Heat sources such as radiators, stoves, or other products that produce heat.
  - In an area where oil or water may be splashed
  - Direct sunlight
  - Mechanical vibration or shock
  - Excessive dust
  - Lack of ventilation, such as cabinet or bookcase
  - Uneven surface

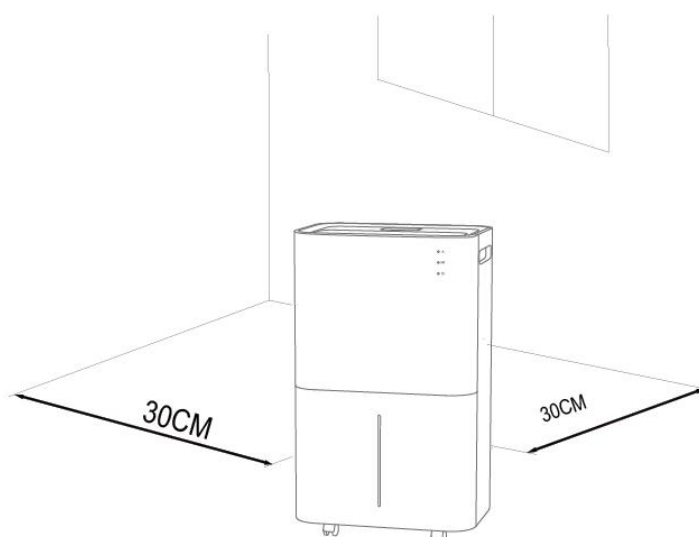

#### WARNING

Install the unit in rooms which exceed 4 m<sup>2</sup>.

Do not install the unit in a place where flammable gas may leak.

### 4.2 OPERATING THE DEVICE SAFELY

- Check the device after unpacking for any damages or scratches on it.
- Operate this unit in an ambient temperature from 5°C to 35°C.
- Do not use outdoors. This dehumidifier is intended for indoor residential applications only.
- Do not operate in close proximity to walls, curtains, or other objects that may block inlet and outlet.
- Keep the air inlet and outlet free of obstacles.
- Adjusting the wind deflector in the upward direction prior to start up.
- If tipped more than 45°, allow the unit to sit upright for at least 24 hours before starting up.

- Keep doors and windows closed for better energy saving.
- Do not operate or store the unit in direct sunlight or rain.
- It is normal for air outlet to feel warm to touch after continuous operation on hot days.
- Empty the water tank before moving the appliance.
- Make sure the Water tank is correctly fitted otherwise the unit will not operate properly.
- The dehumidifier starts up in the mode selected when the unit was last used.
- The dehumidifier starts dehumidifying if the room humidity is 3% higher than the selected humidity.
- There is a protective 3-minutes time delay before operation or shutting down of the compressor.  
Wait 3 minutes for the dehumidifier to resume operation.

## 5. OPERATION

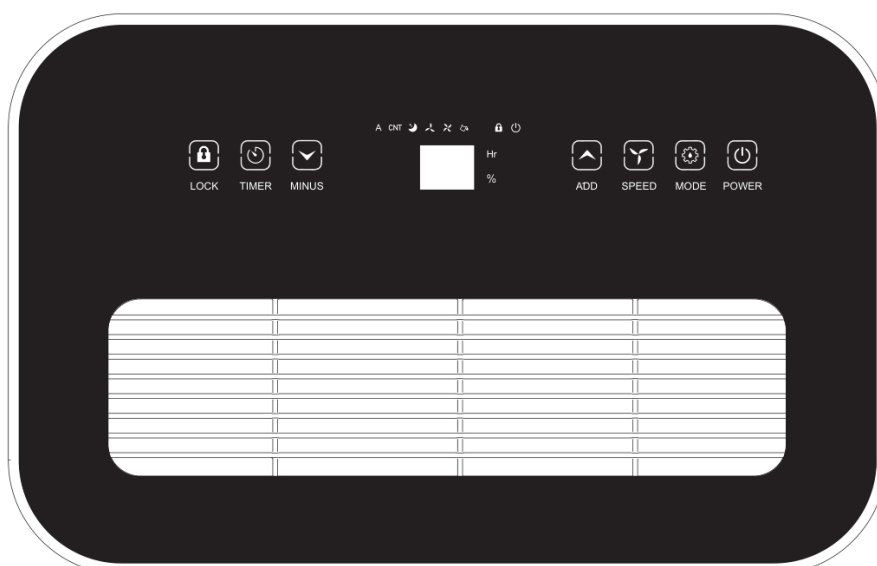

### 5.1 CONTROL PANEL



#### Power

After switching on the power, all the indicators and the screen will be lit for 1 second and then turn off. A buzzer will sound and the power indicator light will be on and the machine will be in standby mode.

Press the power button again and the appliance will start, the machine's default initial humidity setting is 50%RH, the mode is set to automatic and the fan operation to high.

Press this key again, the machine will stop running, and the fan will stop after approx. 30s.



#### Mode

Auto mode - Continuously drying mode - Sleep mode. Press once to switch the mode from one to another, the corresponding indicator lights up.

- **Auto mode:** **A** when room humidity  $\geq$  set humidity +3%, the fan starts working and compressor



starts working after 3 seconds.

When room humidity  $\leq$  set humidity -3%, the compressor stops working and the fan will shut down after a short 30s delay.

Both fan speed and humidity can be adjusted under auto mode.

● **Continuously drying mode:**  The machine continues to run, but the humidity cannot be adjusted.

● **Sleep mode:**  After no operation in 10 seconds, all indicators gradually darken, and the fan speed is automatically switched from high to low. Touch any button to wake up the display. Touch sleep button again to exit the sleep mode. When humidity level  $\leq$  57%, the compressor stops and the fan will shut down after 30s. When the humidity  $\geq$  63% the fan starts then the compressor after 3s.

In sleep mode the fan speed and humidity cannot be modified.



### Humidity

In auto mode you can use these buttons to adjust the set humidity: every time you press the add will increase by 5%, the minus will decrease by 5%. The humidity can range from a minimum of 30% to a maximum of 80%.



### Timer

Press this key to set the timer function of 0-24 hours. The interval is 1 hour. Each time you press the add or minus buttons, the value increases/decreases by 1 hour and then the corresponding timing value is displayed on the screen. Set the value to "00" to cancel the timer function and the timer indicator will turn off.

After the timer is set and completed, the timer LED is on during the timing period. After the timing period the timer LED turns off automatically.

In the running state, set the time to turn off the machine.

in the standby state, set the time to turn on the machine.



### Fan Speed

The fan speed can only be adjusted in the automatic mode. Press this key to switch between the high and low  fan speeds. The corresponding fan speed indicator lights



### Child Lock

A long press this button to operate the child lock function. The child lock indicator lights. All the keys are locked and cannot be operated. Press this button again, the indicator light will go out, and the button operation will be restored.

Shutdown or power off will automatically cancel the child lock function.

## 5. DRAINAGE

### EMPTYING THE WATER TANK

- When the tank is full, The unit will make a buzzing sound, and the “Water Full” light will turn on.
- Press the POWER button to turn off the unit.
- Pull on the water tank and simply slide out of the body of the dehumidifier.
- Empty the water into an area with a drain or outside.
- Clean the inside of the tank as well as the outside.
- Replace the empty tank back into the unit.
- Press the POWER button to resume operating.
- If the Water Full light does not extinguish, check that the float is correctly in place.

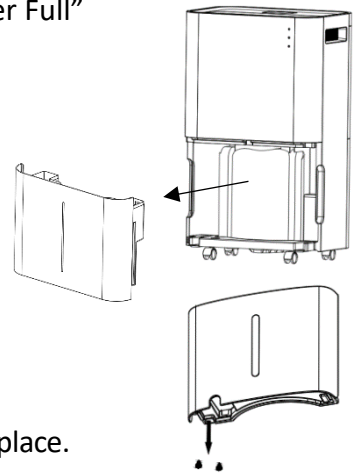

### Warning

1. Do not discard water tank magnets and plastic rivets. Otherwise, the machine will not automatically stop when the water tank is full, and the condensed water will overflow.
2. If the water tank is dirty, rinse with clean water. Avoid using detergents or other solvents as this may cause the water tank to be damaged and leak
3. Replace the empty tank back into the unit. Otherwise, the water full indicator may remain red, and the machine cannot restart.

### CONTINUOUS DRAINING

For continuous operation or unattended dehumidification, please connect the drain hose to the unit. Condensate water can automatically drip into a bucket or drain by gravity.

1. Straighten the drainage pipe
2. Insert one end of the drain pipe into the drain hole and place the other end into the bucket, container, or drain.

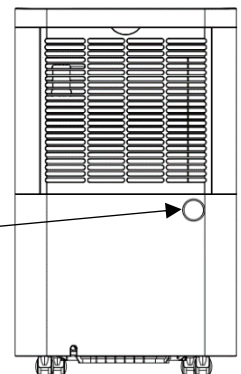

### Warning

1. Please do not block the drain or drainpipe, if the pipe is blocked the condensed water will flow into the water tank.
2. Please do not bend the drainpipe. The height of the drainpipe should be lower than the outlet.
3. The drainpipe should be securely connected to the outlet.
4. Do not submerge the end of the drain hose as this can cause an ‘air lock’ in the hose and prevent the water from draining.

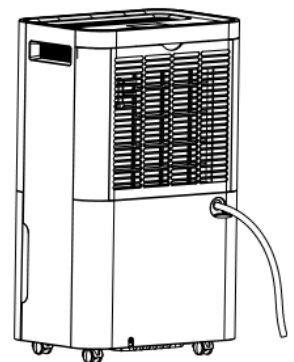

## MAINTENANCE

Note: before cleaning and maintaining the machine, be sure to turn off the machine and pull the power plug to prevent electric shock.

### CLEANING THE AIR FILTER

The filter should be cleaned every 2 weeks.

Dust collects on the filter and restricts the airflow. The restricted airflow reduces the efficiency of the system and if it becomes blocked it can cause damage to the unit.

The air filter requires regular cleaning. The air filter is removable for easy cleaning. Do not operate the unit without an air filter, or the evaporator may be contaminated.

1. Remove the filter from the back of the unit.

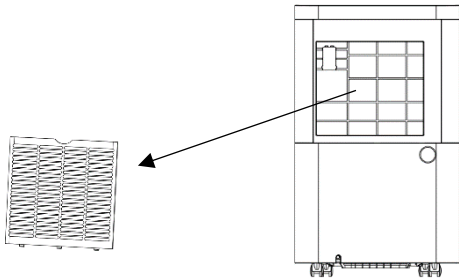

2. Use a vacuum cleaner to gently absorb the dust on the surface. If the filter is very dirty, wash it with water and a soft detergent and dry it thoroughly afterwards.

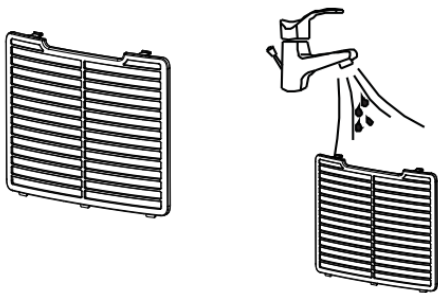

3. Return the filter to the unit.

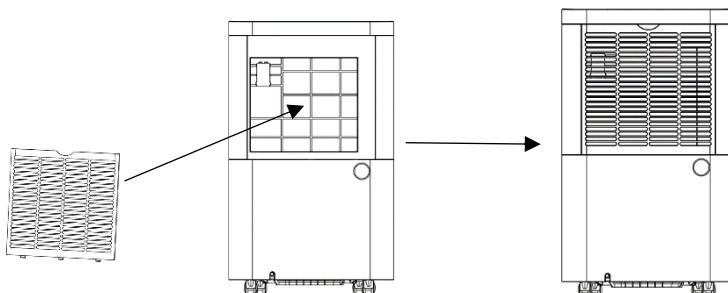

## TROUBLE SHOOTING

### NORMAL OPERATING TEMP.

5°C ≤ to ≤ 35°C

When the ambient temp is lower or higher than the normal operating temperature, the dehumidifier stops.

When the room temperature is between 5°C ≤ & ≤ 16°C, the compressor automatically defrosts at regular intervals; during defrosting, the compressor stops, and the fan keeps running.

### BEFORE CALLING THE SERVICE HELPLINE

Before contacting a service professional, please review the trouble shooting list below that include common issues that are not the result of a defect in workmanship or materials.

Problem	Possible Cause	Solution
Not working	No power supply	Connect to a functioning outlet and switch on
	Water Full Indication Flashes	Drain water tank and reset it, or check water tank is correctly fitted.
	Room temperature < 5°C, or > 35 °C	Unit will not operate to protect the unit. Unit will not work at such temperatures.
Poor function	Is the air filter clogged?	Clean the air filter as instructed
	Is the intake duct or discharge duct obstructed?	Remove the obstruction from the discharge duct or intake duct.
No air intake	Is the filter clogged?	Wash / clean the filter
Loud noise when running	Is the machine put on a flat surface?	Reposition on flat surface.
	Is the filter clogged?	Wash the filter
E2	Humidity sensor problem	Change sensor
LO	Environmental humidity is below 20%	The dehumidifier shuts down for self-protection
HI	Environmental humidity is above 90%	
CL	Low temperature protection, the environmental temperature < 5°C	
CH	High temperature protection, the environmental temperature > 38°C	

## STORAGE

Long-term storage - If you will not be using the unit for an extended period of time (more than a few weeks) it is best to clean the unit and dry it out completely. Please store the unit per the following steps:

1. Press power button to switch off and unplug the unit.
2. Drain the remaining water from the unit and dry thoroughly.
3. Clean the filter and let the filter dry completely.
4. Replace filter in the unit.
5. Place the power cord in the dry water tank.
6. The unit must be kept in upright position when in storage.
7. Store the machine indoors in a dry, well-ventilated place.

### ATTENTION:

The condenser inside the machine should be dried out before the unit is packed away to avoid component damage and mold. Unplug the unit and place it in a dry open area for at least 24 hours to dry it out. Another way to dry the unit is to set the humidity point more than 5% higher than the ambient humidity to force the fan to dry the condenser.

## DISPOSAL

### WARNING!!!

Releasing refrigerant into the atmosphere is strictly forbidden!

Do not dispose of this electrical appliance as unsorted municipal waste, use separate collection facilities designated for refrigerators. Contact your local authority for information regarding the collection systems available. If electrical appliances are disposed of in landfills or dumps, hazardous substances can leak into the groundwater and get into the food chain, damaging your health.



## TECHNICAL SPECIFICATION

Weight:	14.5kg
Power supply:	230V ~
Power consumption:	330W
Tank Capacity:	4 litre
Refrigerant / Charge:	R290 / 55g
Moisture Removal:	20l / Day

## SERVICE WARRANTY

Prem-I-Air guarantees the product free from defects in materials and workmanship for a period of 1 year. Should this unit be operated under conditions other than those recommended, at voltages other than the voltage indicated on the unit, or any attempts made to service or modify the unit, then the warranty will be rendered void. The product you buy may sometimes differ slightly from illustrations. This warranty is in addition to, and does not affect, your statutory rights. If you have any problems with this product, please call our help desk on (0845) 459 4816.

### **Prem-I-Air Appliances Ltd.**

Lancots Lane  
Sutton  
St. Helens  
Merseyside  
**WA9 3EX**

**[www.prem-i-air.co.uk](http://www.prem-i-air.co.uk)**