

DESICCANT DEHUMIDIFIER

USER MANUAL

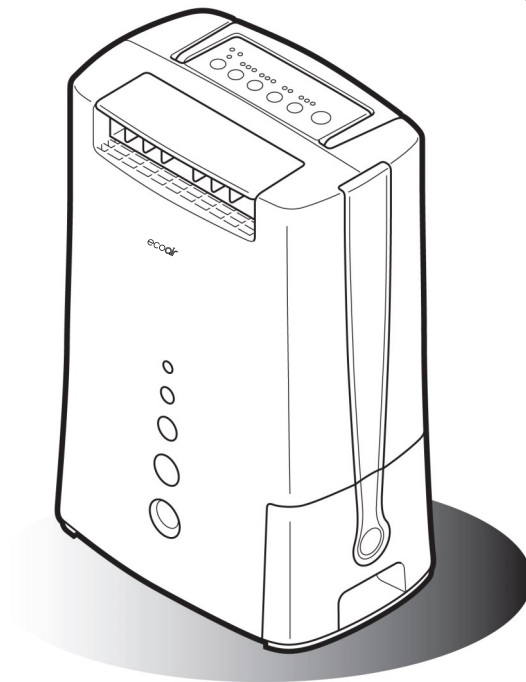

Please read instructions before use
Keep for future reference

Visit ecoair.org to register your product
or terms and conditions

WELCOME

Thank you and congratulations for choosing an EcoAir dehumidifier to help you improve the air quality within your environment. Inside you will find many helpful tips on how to use and maintain your dehumidifier efficiently. Just a little preventative care can save you money and prolong the life of your dehumidifier.

The purpose of the dehumidifier is to remove the excess moisture in the air by detecting the humidity level in the room. By keeping humidity within recommended levels, a dehumidifier combats household damp, mould and mildew. Dehumidifiers can help to reduce the symptoms of asthma, allergies, and other respiratory health conditions. They can also be used to help dry laundry quicker and control moisture-based damage (such as the aftermath of flooding, leaks or rising damp) to valuable belongings and furniture.

HUMIDITY GUIDE

There will always be water vapour in the air. The water vapour (or commonly known as moisture) in the air is measured in Relative Humidity (RH) %. RH is the ratio of the actual amount of water vapour in the air to the amount it could hold when saturated expressed as a percentage. Too much or too little moisture in our homes can be unhealthy and uncomfortable. The optimum humidity level is between 40% and 60% (RH) where we feel most comfortable.

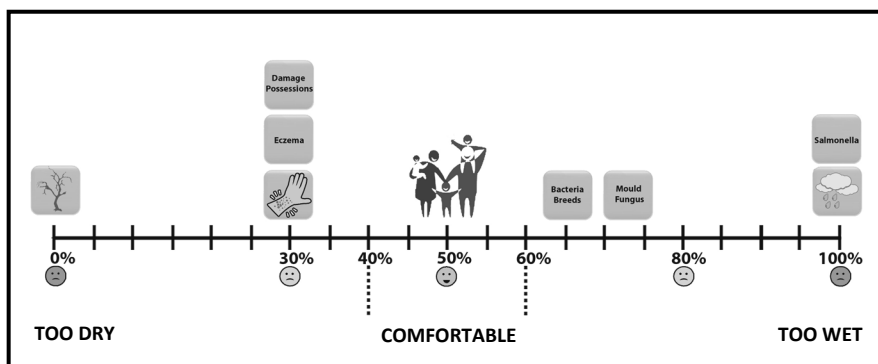

Low humidity

Low humidity indoors causes excess drying which can trigger skin irritations such as eczema, chapped skin and dry nose. It can also damage possessions, such as wooden furniture, musical instruments and artwork by drying it out too much.

High humidity

High humidity indoors causes damp and condensation. The damp left by condensation can damage plaster, wall paper, furniture, vehicles, timber windows, doors and clothes. It can be harmful to our health when bacteria thrives, causing mould and fungus.

Maintaining safe levels of humidity

It is important to maintain a consistent humidity range to preserve furniture, paintings, door and window frames. High humidity causes swelling, corrosion, softening of glues and paint. Low humidity causes shrinking, cracking, warping of wood surfaces and gaps in joints, doors and windows. Frequent changes in humidity levels can accelerate damages to property and belongings.

Condensation

The warmer the air, the more moisture the air can hold than colder air. So, when the air inside the house becomes colder, the moisture contents in the air becomes saturated, and gets heavier resulting in moisture concentration on the coldest parts of the house particularly on the windows, bathroom mirrors and walls. This is condensation, caused by a sudden increase in humidity, cooking, showers, drying clothes, inadequate ventilation and poor thermal insulation.

Condensation does not disappear instantly even with the dehumidifier on. Where excessive condensation appears for example, on your windows, you may want to open your windows to expel the excess humidity for several minutes. It will take a while for the condensation to generally increase the humidity in the room. Once the humidity level in the room around the dehumidifier is increased above the level you have set on the dehumidifier, it will then begin the dehumidification process.

INDEX

Important Safety Instructions	1
BS Plug Wiring	2
The Appliance and Accessories	3
Important Safeguards	4
Installation	5
Setup Continuous Drainage	6
Control Panel	7
Operation	8 - 9
Emptying the Water Tank	10
Cleaning, Maintenance and Storing the appliance	11
Troubleshooting	12 - 13

IMPORTANT SAFETY INSTRUCTIONS

WARNING!

This dehumidifier is intended for use in domestic households and similar working and residential environments and is not intended for outdoor use. It must be used only as a domestic appliance. EcoAir cannot be held liable for damage resulting from incorrect or improper use or operation

- Do not alter or modify the appliance's characteristics in any way. Should repairs be necessary, contact EcoAir's Authorised Service Centre. Self-servicing or unauthorised servicing can be dangerous.
- The appliance must be installed in accordance with the relevant national legislation.
- The appliance is not intended for use by persons (including children) with reduced physical, sensory or mental capabilities, or lack of experience and knowledge, unless they have been given supervision or instruction concerning the use of the appliance by a person responsible for their safety.
- Children and pets should be supervised to ensure they do not play with the appliance.
- Do not use the appliance if the power cable, cord is damaged. It must be replaced by an EcoAir's Authorised Service Centre.
- The appliance must always be placed in an upright position on an even level surface to avoid any damage, during use or transportation and when put into storage.
- The appliance must be plugged into a grounded 3-prong outlet and ensure that the voltage matches the rated specifications. If in doubt, check with a qualified technician.
- Do not use with extension cables or multi sockets. Do not pull or place strain on the power cord when moving appliance.
- Always unplug the appliance before cleaning or maintenance or when not in use.
- The appliance must not be placed or used where the atmosphere may contain combustible gasses, oil or sulphur or solvent, or near heat sources (such as heaters or in server rooms) or excessive dust.
- Do not place or rest any objects on the appliance and do not cover while in use. Always observe the minimum room size for storing and operating the appliance.
- Allow a minimum of 40 cm clearance around the appliance. Do not place any objects in close proximity to the appliance.
- Filter must be cleaned every 2 weeks to avoid dust building up internally causing overheating and malfunction.
- To protect against electric shocks, do not immerse or spray the appliance or any of its parts in water.
- Ensure the air inlet and outlet are not blocked or covered when in use.
- Do not insert fingers or any objects into the air inlet or outlet openings.
- Do not operate or store the appliance under direct sunlight.
- Always switch of the power before unplugging from the socket.
- Do not leave the appliance running or plugged in over a long period of time unattended. Leaving unattended electrical appliances running is unsafe.
- Always make sure your hands are dry when operating the appliance.
- Only operate the appliance within the specified operating temperature range.
- Do not run power cord under carpeting, or cover with rugs or runners. Arrange the cord away from areas where it may become a trip hazard.
- This appliance must not be used outdoor or wet areas such as bathrooms.
- Do not use the Laundry Mode function over a long period of time or unattended. When drying laundry, do not place laundry on the appliance. Always ensure the laundry is placed a safe distance from the dehumidifier at least 40cm.
- Always clean the filter and cover the dehumidifier with a dust sheet when storing the dehumidifier.

BS PLUG WIRING

Should it be necessary to change the plug, please note the wires in the mains lead are colour coded as follows:

BLUE - NEUTRAL

BROWN – LIVE

GREEN AND YELLOW - EARTH

In the event that the colours of the wires in the mains lead of this appliance do not correspond with the coloured markings identifying the terminals in your plug, proceed as follows:

1. The BLUE wire is NEUTRAL and must be connected to the terminal which is marked with the letter N or coloured BLACK.
2. The BROWN wire is LIVE and must be connected to the terminal which is marked with the letter L or coloured RED.
3. The GREEN/YELLOW is EARTH and must be connected to the terminal which is marked with the letter E or  or coloured GREEN or GREEN/YELLOW.
4. Always ensure that the cord grip is positioned and fastened correctly.
5. If a 5A (BS 1363) fused plug is used it must be fitted with a 5A -fuse.
If in doubt consult a qualified electrician.

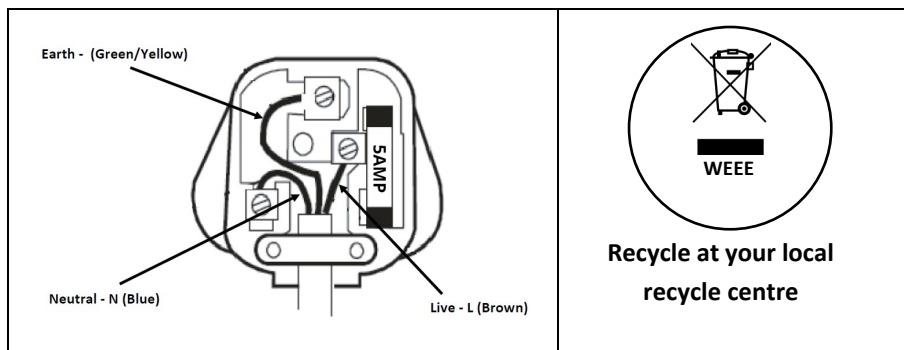

Please note the Earth, Neutral and Live Terminals are marked as E , N and L respectively.

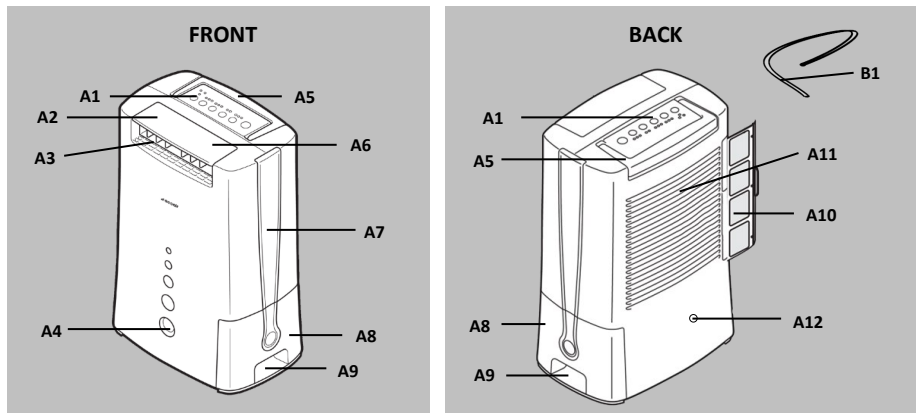

THE APPLIANCE & ACCESSORIES



Accessories List

	
B1	B2

DESCRIPTION	
Key	Description
A1	Control Panel
A2	Louvre
A3	Air Outlet
A4	Water Level Indicator
A5	Handle
A6	3D Louvre
A7	Operation Light
A8	Water Tanks
A9	Grip Handle
A10	Filter
A11	Air Inlet
A12	Continuous Drainage Knockout
Key	Description
B1	Continuous Drainage Hose
B2	User Manual

IMPORTANT SAFEGUARDS

WHERE TO POSITION YOUR DEHUMIDIFIER?

Ensure the unit is a safe distance away from a wall or furniture and away from direct sunlight.

TIP: Position the dehumidifier in the dampest room or somewhere central like a landing or a hallway. As long as the internal doors are open the excess moisture from all of the rooms in the house will migrate naturally towards the dehumidifier and be processed.

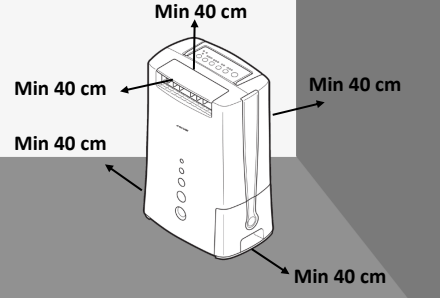

DO NOT PLACE OBJECTS ON OR OVER THE APPLIANCE

Ensure the air inlet (A11) and air outlet (A3) are not obstructed. Obstruction will cause overheating and malfunction.

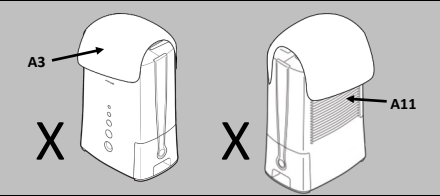

DRYING YOUR LAUNDRY

Never place wet laundry over the appliance. Dry the laundry on a rack with a minimum distance of 40 cm.

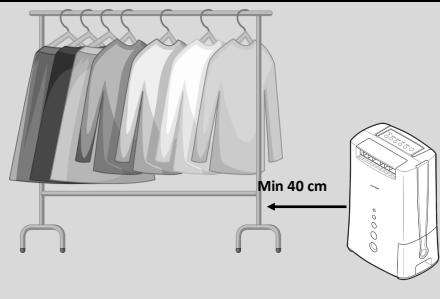

ROOM SIZE

- Never use in small confined area. (Broom cupboard, boiler room, unventilated rooms, in close proximity to a heat source such as heater, tumble dryer, cooker).

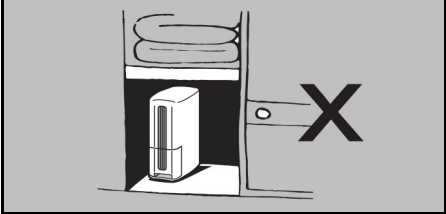

DO NOT SPLASH

- Do not wash the appliance or immerse in water
- Do not allow water to drip on to the appliance

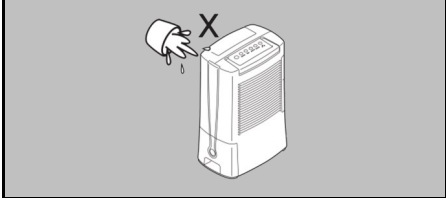

PLACE ON EVEN LEVEL FLOOR

- Always operate appliance on an even level floor to avoid leakage
- If appliance is on carpet, ensure the appliance is stable and level

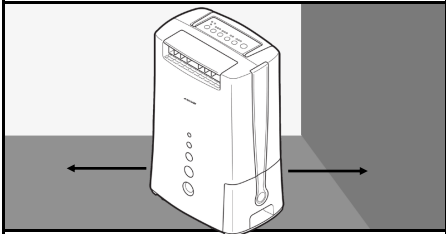

IMPORTANT

- Do not move the appliance or remove the water tank when the dehumidifier is running. It may cause damage, electric shock, water leak or spills.
- After turning the dehumidifier off, do not remove the power plug from the power socket immediately, allow the appliance to cool down for a minimum 5 minutes to help protect the internal components.
- Dusty, building sites or an industrial environment where particles can clog up the filter or internal components.

INSTALLATION

PLEASE READ IMPORTANT SAFEGUARDS BEFORE INSTALLATION

FIND A SUITABLE POSITION

- Position the dehumidifier in the dampest room or somewhere central like a landing or a hallway. As long as the internal doors are open, the excess moisture from all of the room in the house will migrate naturally towards the dehumidifier and be processed.
- If there is a problematic area or a room in a high humidity level, use a hygrometer to measure (available to purchase at ecoair.org) in the property, you may wish to place it in that area initially. Once the problem is settled you may wish to relocate to the location above.
- Please refer to the important safeguards on the previous pages when positioning the dehumidifier, such as a safe distance away from the wall, avoid confined areas, ensure floor is even and level surface.

INSTALLING THE DEHUMIDIFIER

- Unpack the dehumidifier and plug in to the socket.
- Ensure there is a minimum distance of 40 cm around the dehumidifier.
- Check that the dehumidifier is level to avoid any water leaks.
- Turn on the dehumidifier to start dehumidification.

ZEOLITE

- When you first use the dehumidifier and periodically thereafter you may notice a smell coming from the dehumidifier. This is caused by the Zeolite desiccant material and is NOT a sign that the dehumidifier is faulty, nor is it harmful to humans or pets.
- The Zeolite absorbs odours from items such as cigarettes, cosmetics, hair sprays, building materials and new furniture and then when the desiccant is heated the smell is discharged into the room. (This smell has been described as being like a burning smell or a sour smell). This is normal and will NOT last long, nor is it a sign of a fault.

INITIAL OPERATION

- When you first use your dehumidifier it will work hard to reduce the room humidity to your set target humidity. This is the time when it will produce most of the water and need emptying more frequently. As the room become dryer, the dehumidifier collects less water. This is normal.
- Once the power is restored after a power failure, the dehumidifier will continue to operate at the selected settings prior to the power failure.

SETUP CONTINUOUS DRAINAGE

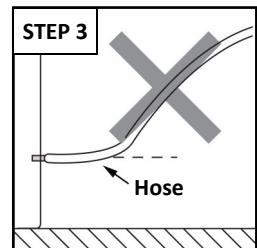
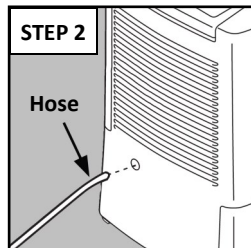
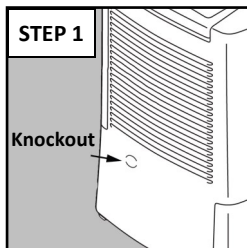

Use a hose with an inner diameter of 12mm for continuous drainage:









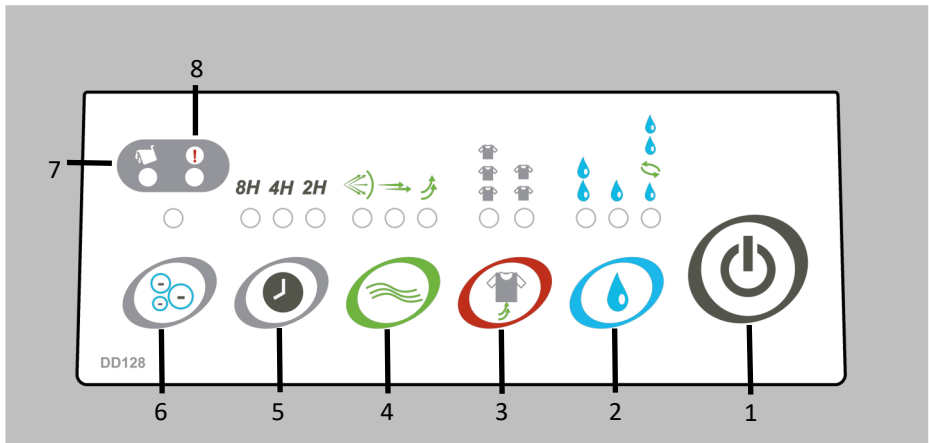



1. Use a screwdriver to remove the knockout at the back.
2. Ensure the water tank is well fitted in position. Then, push the hose (**B1**) through the knockout and make sure it attaches firmly to the open tap securely.
3. Once the hose is securely attached to the open tap, lead the other end of the hose to an appropriate drain at a downward slope with no sharp bends.

NOTE:

- When using the dehumidifier with a continuous hose attached, never pull out the tank. This may cause water leakage or damage to the open tap. If you need to remove the water tank, ensure that the hose is disconnected first.
- Never leave the end of continuous drainage hose outside when the temperature is below 1°C to avoid leakage. (When the outdoor temperature is at freezing point the water will not flow freely and this will cause a blockage consequently pushing the any condensation back to the dehumidifier and leakage will occur).



CONTROL PANEL





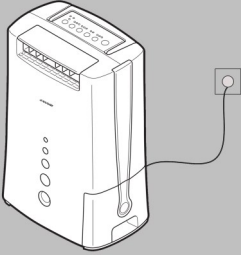







1. **Power Key** - Turn unit on **ON/OFF**.
2. **Dry Mode** - Select **AUTO**    or **ECONOMY**  or **HI**  settings.
3. **Laundry Mode** - Select **NORMAL**   or **TURBO**    modes.
4. **Swing Mode** - Select **UP**  **FRONT**  **WIDE**  or **HOLD**.
5. **Timer Key** - Select **2** or **4** or **8** hours' timer on.
6. **Ioniser Key** - Select **IONISER** for cleaner air.
7. **Check Indicator** - Indicator lights up when the unit needs attention.
8. **Water Full Indicator** - Indicator lights up when the water tank is full or incorrectly installed.

OPERATION

ON/OFF 	
TO OPERATE UNIT	<ul style="list-style-type: none"> Place the unit in an upright position on an even level surface. Plug the unit into the mains socket. Press the ON/OFF button to operate the unit. Now select Mode. To switch the unit OFF, Press the ON/OFF button. Note the fan will run for 2 minutes, to help cool and protect the internal components. (TIP: do not unplug the power socket until the fan stops)
	

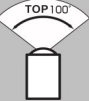
LAUNDRY MODE 	
Use for drying clothes. The appliance will continuously dry the air until you switch to one of the Dry Modes. It typically takes 2 – 4 hours to dry your laundry.	
 Normal	<p>Select Normal mode for maximum energy saving and quiet operation.</p> <ul style="list-style-type: none"> Use this mode for normal daily use. Highly recommended for night use.
 Turbo	<p>Select Turbo mode for rapid dehumidification.</p> <ul style="list-style-type: none"> For quick drying. <p>Tip: Once you reach desired RH, switch from TURBO to NORMAL for energy savings. Use a hygrometer to measure the ambient humidity.</p>
IMPORTANT: Avoid using the Turbo mode for normal daily use. You may use to dry very damp rooms over 2 – 3 days and for Laundry. For daily use, select Economy mode.	

DRY MODE 	
 Auto	<p>Select to keep the room at a comfortable level</p> <ul style="list-style-type: none"> Toggles automatically to control humidity to approximately 50-60% RH. Optimises energy saving and comfortable humidity level.
 Economy	<p>Select to run in Economy mode</p> <ul style="list-style-type: none"> The unit dehumidifies in Economy mode and in a quiet setting to approximately 50-60 % RH. Use this mode in your daily normal household once the ideal humidity level has been reached. Highly recommended for night use.
 Hi	<p>Select High mode to quickly control high levels of humidity</p> <ul style="list-style-type: none"> The unit brings the humidity down to approximately 40-45% RH to control problem areas quickly. Once humidity is controlled, switch back to Auto or Economy

SWING MODE 	
Swing for louvre directions	
 Up	<ul style="list-style-type: none"> The louvre (A6) automatically swings in an upward range of approximately 100° 
 Front	<ul style="list-style-type: none"> The louvre (A6) automatically swings in a front range of approximately 50° 
 Wide	<ul style="list-style-type: none"> The louvre (A6) automatically swings in a wide range of approximately 150° 
Hold	To hold the swing, press Swing until LED is off.

OPERATION

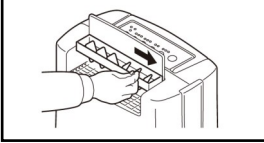
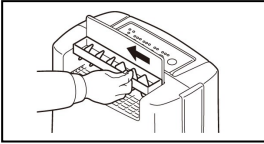
3D LOUVRE	
Wide Airflow	<ul style="list-style-type: none"> Rotate to the WIDE position 
Spot Airflow	<ul style="list-style-type: none"> Rotate to the SPOT position 
<p>Note: To avoid damage, do not touch the louvre whilst in swing mode.</p>	

TIMER 	
Press the "TIMER" Key to select your desired running time	
2H 2 Hours	<ul style="list-style-type: none"> The unit will automatically switch off at the end of the selected time period.
4H 4 Hours	<ul style="list-style-type: none"> As the time counts down the LED lights will indicate the time remaining.
8H 8 Hours	<ul style="list-style-type: none"> When no "TIMER" is set (the LED is off), the unit will run based on the mode you have selected.

IONISER 	
<ul style="list-style-type: none"> Press the "IONISER" Key to turn the ioniser ON or OFF. 	
<ul style="list-style-type: none"> When the LED is on, the unit releases negative ions from the air outlet to purify the air. 	
<p>TIP: Whilst the dehumidifier is running, turning on the ioniser effectively purifies the air with negative ions and silver ion filtration.</p>	

CHECK LIGHTS 	
Water Full Indicator	<ul style="list-style-type: none"> Lights up when water tank is full or not properly inserted.
Check Indicator	<ul style="list-style-type: none"> Check and clean the filter. Ensure filter is cleaned every 2 weeks. Dehumidifier needs to cool down. Switch OFF and leave for 30 minutes and turn on again. This is normal. In low humidity or temperature conditions. In high temperature condition over 40°C or low temperature below 1°C
<p>TIP: When the check light comes on, remove the plug from the socket. Move the unit to another room after it cools down or when conditions allows.</p>	

EMPTYING THE WATER TANK

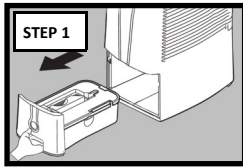

Remove water tank

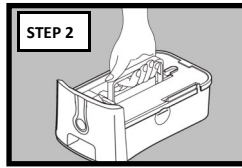

Lift by the handle

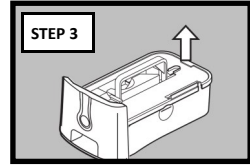

Remove the lid

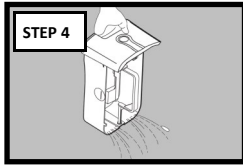

Pour the water away

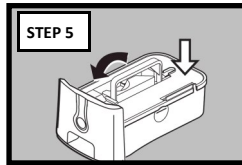

Restore the cover and the handle

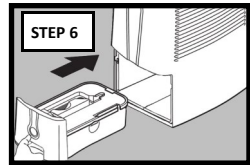

Insert the water tank

The Water Full/Check Indicator lights up when the water tank is full. The appliance will stop operating. Allow to stand for approximately 30 minutes to ensure all water collected drips into the water tank.

1. Gently pull the water tank out. Wipe dry the internal compartment
2. Lift by the handle gently.
3. Remove the tank lid.
4. Pour the water away.
5. Clean the water tank, restore the cover and handle.
6. Insert the water tank back into to the correct position. (The Water Full light indicator illuminates if the water tank is not correctly in position. If this happens, reinsert again).

NOTE :

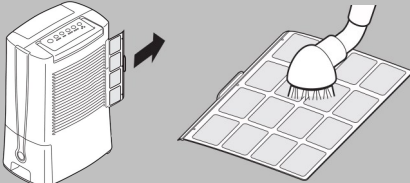
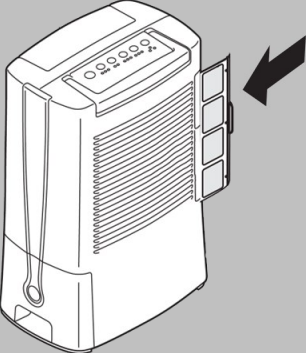
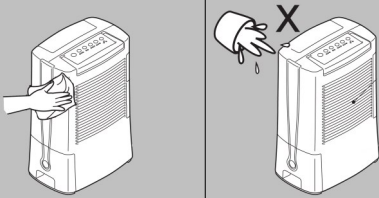

- Clean the water tank with mild detergent if necessary. Do not use solvent, abrasive or hot water. (After Step 4).
- When cleaning the water tank, take caution to avoid damaging the float.
- Do not tilt the dehumidifier when removing the water tank. This is to prevent water leaking which may cause electric shock.

CLEANING, MAINTENANCE & STORING THE APPLIANCE

<p>STEP 1 - CLEANING YOUR FILTER</p>	<p>STEP 2 - REPLACING YOUR FILTER</p>
	
<p>1. Turn off and leave for 5 minutes, then unplug the dehumidifier. Remove the filter.</p>	<p>It is recommended that the outer filter is replaced every 6 months for optimal performance and hygiene standards. To purchase a replacement filter please visit: www.ecoair.org</p>
<p>2. Clean the filter with a brush or vacuum cleaner. (Washing will weaken the germicidal effect of the filter).</p>	<p>STEP 4 - STORING YOUR DEHUMIDIFIER</p>
<p>3. Reinsert the filter back into position.</p>	<p>1. Turn off the dehumidifier, wait 30 minutes and unplug the dehumidifier from the power socket.</p>
<p>Tip: Clean your filter every 2 weeks to keep your air clean and prolong the life of your dehumidifier. The frequency will depend on conditions of operation. Filter must be cleaned every 2 weeks to avoid overheating and malfunction.</p> <p>Note: If the filter is covered with dust, the airflow and the performance of the dehumidifier will be affected.</p>	<p>2. Leave the dehumidifier to drain for approximately one day. Clean and dry the water tank.</p>
<p>STEP 3 - CLEANING YOUR DEHUMIDIFIER</p>	<p>3. Clean the filter and the dehumidifier. Cover the dehumidifier to prevent it from gathering dust. Store upright in a cool dry place.</p>
<p>1. Turn off and leave for 5 minutes, then unplug the dehumidifier.</p>	<p>4. Do not expose to direct sunlight.</p>
	
<p>2. Clean the surface with a soft damp cloth.</p>	
<p>3. Dry thoroughly with a towel after cleaning.</p>	
<p>4. For cleaning tank, see Emptying the Water Tank section.</p>	
<p>Caution:</p> <ul style="list-style-type: none"> Do not wash the unit or immerse in water. Do not let water drip into the air inlet or outlet. When cleaning the water tank, take caution to avoid damaging the float. 	

TROUBLESHOOTING

CHECK THE FOLLOWING POINTS BEFORE CONTACTING TECHNICAL SUPPORT.

PROBLEM	REASON	SOLUTION
 No Power	Dehumidifier is not plugged in or there is no power supply	Plug into a main socket and switch ON. If necessary, try another main socket.
 Water Full / Check Light On	Filter clogged *	Check and clean or replace the filter
	The air inlet or outlet is blocked or covered	Remove obstructions
	Water tank is full or installed incorrectly	Empty water tank or re-install correctly
	Ambient temperature or humidity level out of range	Check that the temperature and humidity are within the operating ranges, use a hygrometer to measure (available to purchase at ecoair.org)
	Water float out of position or broken	Restore position or replace with the water tank
Noisy	Water tank or filter fitted incorrectly	Check and refit the water tank or filter Check unit is on an even level surface
	Foreign object fallen through the vent into the dehumidifier	Contact support@ecoairgb.com for AdHoc Service
	Dehumidifier placed on an uneven surface	Place on an even surface. If necessary test with a spirit level

- * Dust can build up internally inside the dehumidifier, causing obstruction to airflow and over-heating. This will cause malfunction. Common symptoms are Check Light On, Water Leaking and Not Collecting Water (see details above). When this happens, you will need to request a service at our Service Centre. * Clean the filter regularly (recommended every 2 weeks) to avoid malfunction.

In the unlikely event of a problem with your product, please refer in the first instance to:
ECOAIR TECHNICAL SUPPORT
www.ecoair.org/support

TROUBLESHOOTING

CHECK THE FOLLOWING POINTS BEFORE CONTACTING TECHNICAL SUPPORT.

PROBLEM	REASON	SOLUTION
Not Collecting Water	Set humidity is reached	Your target humidity settings have been reached. This is normal.
	Room is very cold or very dry for the current settings	Readjust the humidity setting or increase the room temperature
	Filter dusty *	Clean the air filter or replace it
	Dehumidifier set up incorrectly	Refer to manual for important safeguard, installation and operation.
	Room Temperature is too hot	Turn off the dehumidifier. Decrease the room temperature and check the operating temperature range, room size
Water Leaking	Dehumidifier on uneven surface or water tank fitted incorrectly	Ensure the dehumidifier is on a flat, even surface, use a spirit level to check, remove tank and replace correctly
	Filter clogged *	Clean or replace filter *
	Removing the tank whilst the dehumidifier is running	Always unplug the dehumidifier and allow 30 minutes before removing the tank
	Moving or tilting the dehumidifier whilst water residue remains inside the dehumidifier	Always turn off the dehumidifier, wait 30 mins, empty the tank and reinsert the tank before moving the dehumidifier.
	Damaged water tank	Remove the water tank, fill with water and place on a hard even surface to test for leakage
	The continuous drainage is clogged or loose.	Check the continuous drainage hose and its connection
	Removing the tank whilst dehumidifier is setup on continuous drainage	Check the continuous drainage hose and its connection

- * Dust can build up internally inside the dehumidifier, causing obstruction to airflow and overheating. This will cause malfunction. Common symptoms are Check Light On, Water Leaking and Not Collecting Water (see details above). When this happens, you will need to request a service at our Service Centre. * Clean the filter regularly (recommended every 2 weeks) to avoid malfunction.

In the unlikely event of a problem with your product, please refer in the first instance to:
ECOAIR TECHNICAL SUPPORT
www.ecoair.org/support