



MeacoCool Pro Series

12,000 - 16,000

Air Conditioner

Instruction Manual

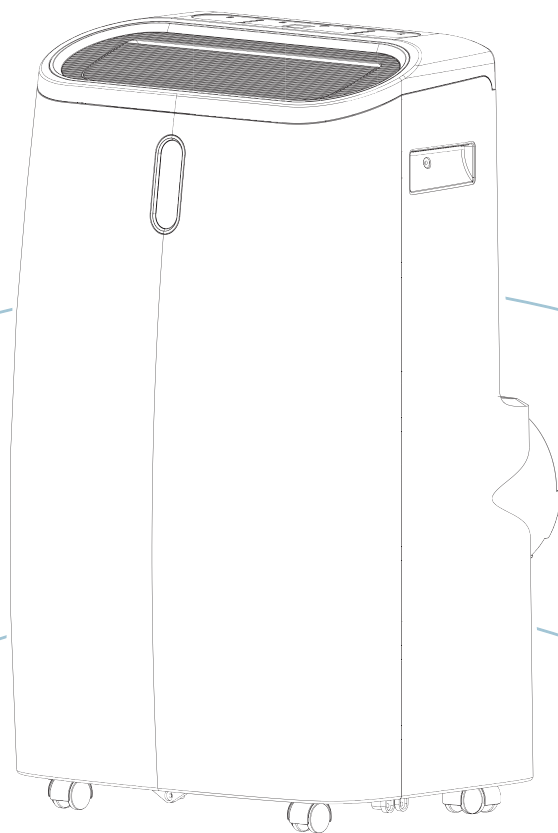

Thank you for choosing Meaco

Our powerful air conditioners are great cooling solutions for single rooms, creating a comfortable atmosphere in your home or office. They have the added benefit of fan and dehumidifying functions for circulating air and removing excess moisture. They're self-contained systems that do not require any permanent installation, which means you can move the air conditioner to the area or room where it is most needed.

This manual contains important information on the use and care of your air conditioner. Please take some time to read this manual to take full advantage of your air conditioners' many benefits and features.

Contents

Safety information	1
Register your Meaco warranty	5
What's included	7
Product identification	8
First steps	9
Installation	10
Operation	13
Maintenance	18
Storing	19
Troubleshooting	19
Meaco customer care	20
Specifications	21
Warranty terms & conditions	22

Safety information

Important safety instructions



This air conditioner must not be used in rooms under the following conditions:

- Potentially explosive atmosphere
- Aggressive atmospheres
- Featuring a high concentration of solvents
- An extremely high ratio of dust
- Rooms smaller than 5.2m²

Keep children away: Do not allow children to play with or around this air conditioner, as it could result in injury. Be sure the air conditioner is inaccessible to children when not attended. This air conditioner is not intended for use by persons (including children) with reduced physical, sensory or mental capabilities, or lack of experience and knowledge, unless they have been given supervision or instruction concerning use of the air conditioner by a person responsible for their safety.

Keep the air conditioner grounded: Always operate the air conditioner with a grounded plug and a grounded electrical outlet. A grounded plug is an essential safety feature that helps reduce the risk of shock or fire.

Protect power cord from damage: Never operate the air conditioner with a damaged power cord, as this may lead to electrical or fire hazards. If the power supply cord is damaged, it must be replaced by a cord of the same type and amperage rating.

Extension cords: Extension cords must be grounded and able to deliver the appropriate voltages to the air conditioner.

Plug use: Do not unplug the air conditioner while it is in operation. Do not unplug by pulling the power cord. When cleaning, always unplug from the mains.

Handle with care: Do not drop, throw or crash the air conditioner. Rough treatment can damage the components or wiring and create a hazardous condition. Do not insert fingers or other objects into the air outlet. Do not immerse or expose the air conditioner to rain, moisture or any other liquid.

Run on a stable surface: Always operate the air conditioner on a stable, level surface, for example the floor or a strong counter, so that the air conditioner cannot fall and cause injury. Do not leave the air conditioner running unattended. Do not tilt or turn over the air conditioner.

Keep out of water: Never operate the air conditioner in pooled or standing water, as this may create a risk of injury from electrical shock. Do not store or operate outdoors. If electrical wiring or components become wet, thoroughly dry them before using the air conditioner. If in doubt do not use the air conditioner and consult a qualified electrician or a Meaco approved engineer.

Keep air intakes clear: Do not clog or block the air intakes by placing the air conditioner too close to curtains, walls or anything that will restrict the air inlet. Do not immerse or expose the air conditioner to rain, moisture or any other liquid. Any of these actions may cause the air conditioner to overheat and result in a fire or electrical hazard.

Keep electrical components dry: Never allow water inside the air conditioner's electrical components. If these areas become wet for any reason, thoroughly dry them before using the air conditioner. If in doubt, do not use the air conditioner and consult a qualified electrician or a Meaco approved engineer.

The operator must make the operating instructions available for the user and make sure that the user does understand the manual.



The MeacoCool Pro Series 12000 BTU, 12000CH BTU, 14000 BTU, 14000CH BTU, 16000 BTU and 16000CH BTU air conditioners use R290 refrigerant gas to comply with European Environmental Directives. R290 is kinder to the environment and is part of attempts to reduce global warming as it has a low greenhouse effect (GWP).

When using the MeacoCool Pro Series air conditioner you must take into account the following:

- This air conditioner uses about 240 grams of R290 refrigerant in the 12000 BTU and 12000CH BTU model, 270 grams of R290 refrigerant in the 14000 BTU and 14000CH BTU model and 265 grams of R290 refrigerant in the 16000 BTU and 16000CH BTU model which is flammable. Therefore, it is part of a sealed system and must only be serviced by a trained Meaco engineer.
- Do not use or store this air conditioner in a room smaller than 5.2m² to prevent a fire or explosion hazard if there is a leak of refrigerant and the gas comes into contact with an ignition source.
- Do not use in a room with any continuous sources of ignition, for example open flames, gas fires or hobs, cigarettes or any other sources of ignition.
- If the air conditioner is installed, operated or stored in a non-ventilated area, then the room must be designed to prevent the accumulation of refrigerant leaks resulting in a risk of fire or explosion due to ignition of the refrigerant caused by electric heaters, cookers, or other sources of ignition.
- R290 refrigerant gas is odourless.
- Do not puncture either during the air conditioners working life or after. At the end of life dispose of following local recycling regulations.
- If there is any damage to the air conditioner then do not use it and contact Meaco or your retailer.
- As with all air conditioners, always keep upright and leave the air conditioner standing upright for 24 hours before using it upon receipt.

Failure to comply with these instructions could result in fire, damage to property, serious injury or potentially death.

Individuals who operate or work on the refrigerant circuit must have the appropriate certification issued by a national accredited organisation that ensures competence in handling flammable refrigerants according to a specific evaluation recognised by national associations in the industry and compliant with the latest R290 guidance.

Servicing should only be carried out by a Meaco approved engineer using original Meaco parts to prevent damage to the unit and potential injury to the engineer.

Instructions about the disposal



Correct disposal of this product (Waste Electrical & Electronic Equipment)

This marking indicates that this product or accessories should not be disposed of with other household waste at the end of their working life. To prevent possible harm to the environment or human health from uncontrolled waste disposal, please separate these items from other types of waste and recycle them responsibly to promote the sustainable reuse of material resources. Users should contact either the retailer where they purchased this product, or their local government, for details of where and how they can take these items for environmentally safe recycling.

Declaration of conformity

Hereby, Meaco declares that this radio equipment is in compliance with Directive 2014/53/EU and with the relevant statutory requirements. The full text of the declaration of conformity is available at the following internet address: <https://www.meaco.com/pages/compliance-data>.

Wiring Instructions

Should it be necessary to change the plug, please note the wires in the mains lead are coloured in accordance with the following code:

Blue: Neutral

Brown: Live

Green and yellow: Earth

As the colours of the wires in the mains lead of this appliance may not correspond with the coloured markings identifying the terminals in your plug, proceed as follows:

The **BLUE** wire is the **NEUTRAL** and must be connected to the terminal which is marked with the letter **N** or coloured **BLACK**.

The **BROWN** wire is the **LIVE** and must be connected to the terminal which is marked with the letter **L** or coloured **RED**.

The **GREEN/YELLOW** is the **EARTH** and must be connected to the terminal which is marked with the letter **E** or coloured **GREEN** or **GREEN/YELLOW**.

Always ensure that the cord grip is positioned and fastened correctly.

Only ever use the same fuse as fitted in the original product, if in doubt please contact Meaco first, or a qualified electrician.

Example wiring for a Standard British Plug:

Note - The Earth Terminal is marked with the letter E or Earth Symbol 

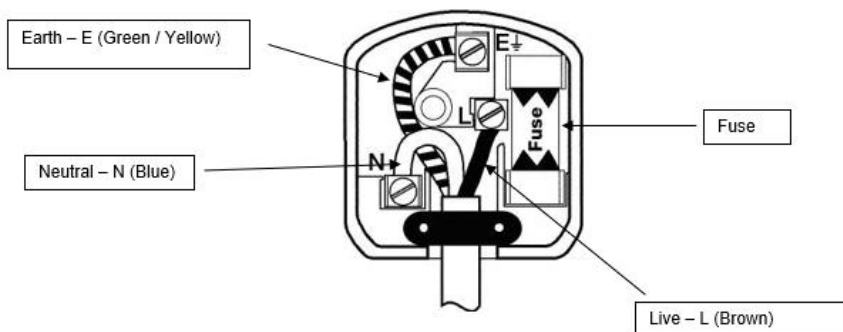

Register your Meaco warranty

Your Meaco air conditioner comes with a free 2 year warranty, simply register your details online and you'll be covered for parts and labour for 2 years from the date of purchase, subject to the terms and condition of the warranty. As a thank you, you will be entered into our monthly free prize draw to help support the David Shepherd Wildlife Foundation.

Where to find your air conditioners serial number

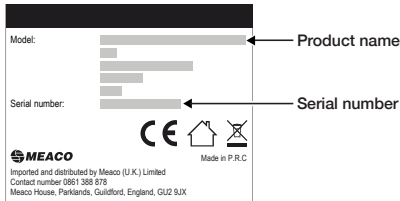

The serial number can be found on the rating label at the rear of your air conditioner

Remember to keep a copy of your purchase receipt safe, you will need to show this to our Customer Service team should you need to make a warranty claim.

Ways to register your Meaco warranty



Register online

Visit our website to register your free two year warranty online:
<https://www.meaco.com/pages/register-your-warranty>

Register by phone

Call our Customer Service team to register your free two year warranty over the phone: 01483 234900
Opening times: Monday - Friday 9am - 5:30pm

Meaco App

Control your new air conditioner with the Meaco app.

Scan the QR code to install the Meaco app or download the Meaco app from the App store or Google Play.



Open the app and follow the instructions to create a new account and pair your air conditioner.

Connecting your air conditioner to your Meaco app

1. Plug the air conditioner into the mains and press the power button.
 2. The Wi-Fi indicator will flash - if there is no connection after 3 minutes the LED will turn off. If you need to connect your Wi-Fi later, hold the timer button for 5 seconds and the Wi-Fi indicator will start flashing again.
 3. In the Meaco app, press the + button in the top right hand corner and then 'Add device'.
 4. The app will search for nearby devices and your air conditioner will appear, click 'Add'.
 5. Once the air conditioner is successfully connected to Wi-Fi, the Wi-Fi symbol will stop flashing.
-

What's included

Carefully unpack the air conditioner. Keep all packaging materials away from children. We recommend flat packing and keeping hold of the box should you need it in the future.

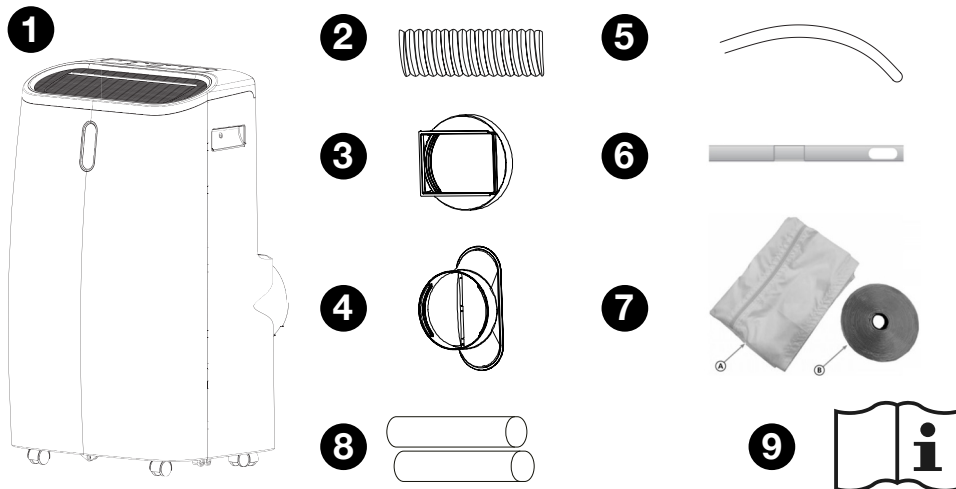

1. MeacoCool Pro Series Air Conditioner

2. Duct

3. Duct machine adaptor

4. Duct window adaptor

5. Drainage hose

6. Standard window kit

7. Flexible window kit

8. 2x Drainage bungs

9. Instruction manual

Product identification

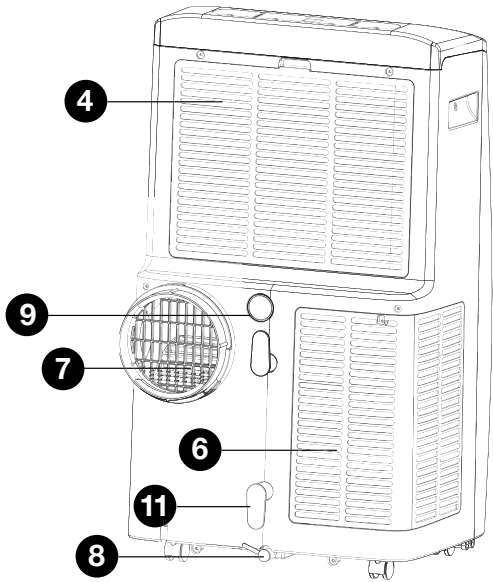
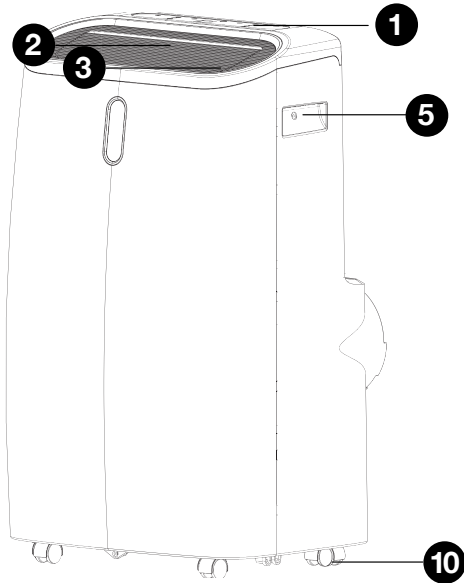

- 1. Control panel
- 2. Air outlet
- 3. Louvre
- 4. Filter & air inlet
- 5. Handle
- 6. Filter & air inlet
- 7. Air exhaust

- 8. Lower drainage port
- 9. Central drainage port
- 10. Castors
- 11. Cable tidy

The 2 x drainage bungs can be found inserted into the lower drainage port and central port.

First steps

When you first receive your air conditioner, it is important you follow the steps below carefully:

1. Check your air conditioner and its box and packaging for any transport damage. In case of damage, inform the sender immediately.
2. Leave the air conditioner to stand for 24 hours before turning it on. This will allow any refrigerant that may have moved during transit to settle.
3. When using the air conditioner make sure it is placed on a level surface with at least 50 cm of free space around it to allow for adequate air flow.
4. Do not operate the air conditioner near walls, curtains or other objects that may block the air outlet or air inlet.
5. Keep the packaging for the air conditioner in a safe place in order to be able to dispatch the air conditioner safely if it requires a service. In order to save space, you can simply cut through the adhesive tape using a knife and fold the cardboard box.

Air Conditioner Principles

Cooling works best in a well-sealed room with as little heat gain from sunlight as possible. We advise keeping all doors, windows and curtains/blinds closed before using the air conditioner in order to stop the room getting hot in the first place. This is especially useful in bedrooms where pre-cooling the room before going to bed is more sensible than trying to sleep with an air conditioner turned on in the room.

Installation

The air conditioner needs to be vented to the outside in order to remove hot air, this is typically done through a window. The duct provided is 1.8 metres long and cannot be extended. A 2m duct is available to purchase from meaco.com.

There are two different window kits provided: the Standard window kit and the Flexible window kit – only one window kit needs to be used depending on the type of window/door you wish to use. We recommend using the Standard window kit for all sliding windows and doors, and the Flexible window kit for all other types.

Steps 3 and 4 are only required when using the Standard window kit. For instructions on how to set up the Flexible window kit, see separate leaflet included with the Flexible window kit.

The following steps are essential if you wish to use your air conditioner in Cool or Heat mode, and recommended if you want to use your air conditioner in Dry Mode.

Step 1: Connect the duct machine adaptor to the duct using a twisting motion. Do not force the connection as this could cause damage.

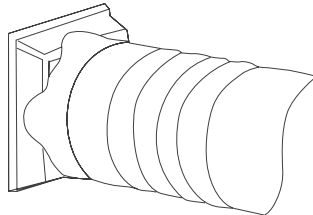

Step 2: Connect the duct window adaptor to the other end of the duct using a twisting motion. Do not force the connection as this could cause damage.

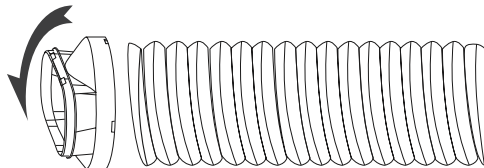

Step 3: Attach the duct to the window kit using the duct window adaptor.

- Connect the duct to section B.
- After completing the assembly, fit and adjust sections A and C depending on the length you require, using the window kit screws provided.

Plate A: 650 mm (L) x 117 mm (W) x 20 mm (D)

Plate B: 650 mm (L) x 110.5 mm (W) x 14.5 mm (D)

Plate C: 510 mm (L) x 117 mm (W) x 20 mm (D)

Please note the diagram is schematic drawing for reference only. Install the duct via the duct window adaptor into the hole in section B.

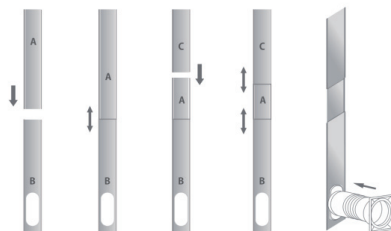

Step 4: Close the window to secure the window kit in place. It is recommended that the gap between the window kit and the sides of the window are sealed for maximum efficiency.

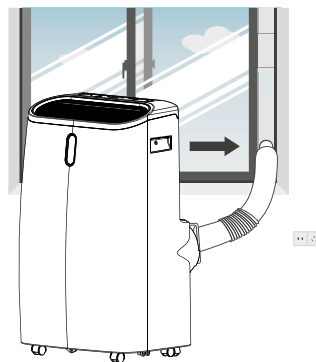

Step 5: Close the window to secure the window kit in place. It is recommended that the gap between the window kit and the sides of the window are sealed for maximum efficiency.

*** Whilst cooling, do not remove this bung. This is the water reservoir where water sits until it is evaporated out via the duct.**

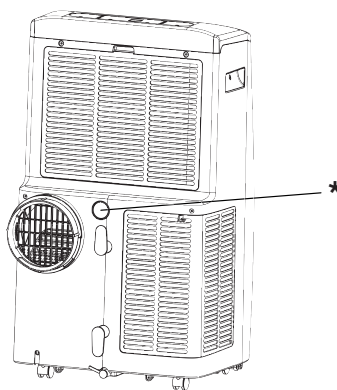
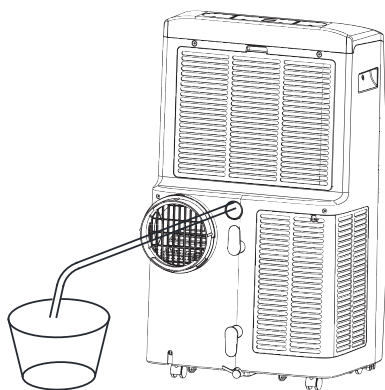

Step 6: Extend the duct to the desired length avoiding any bends or kinks in the hose.

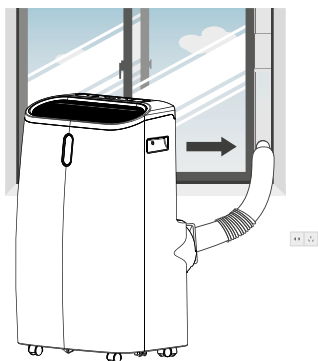

Step 7: If using the air conditioner in Dry Mode or Heat Mode the drainage hose must also be connected (see page 17).

Step 8: Plug the air conditioner into the mains and turn on using the power button. The louvre will open automatically when the power button is pressed.

Operation

Control Panel

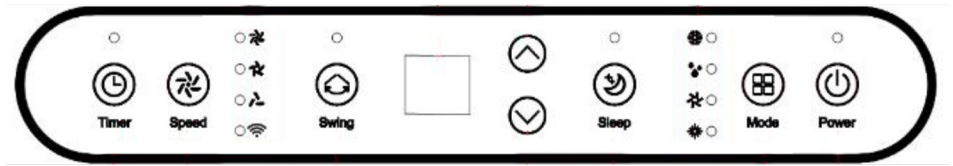

Note: the Heat LED will only show on the display if you have a CH (Cooling and Heating) model.

When the air conditioner is plugged into the mains it will enter Standby mode. All lights on the display will turn on for one second and then switch off (apart from the power button which will continuously stay lit up).



Power button: Press the power button to switch the unit on – the unit will enter the default fan mode and the default temperature (23°C). The compressor will start working with a 3-minute delay. Press the power button again to turn the unit off, the compressor will stop at once and the fan will stop ten seconds after the power button has been pressed.



Sleep button: Press the sleep button to enter sleep mode. The air conditioner will run on low fan speed only to reduce the noise level and the LED display will dim. This mode can only be activated in Cool or Heat Mode. In Cool Mode: after 1 hour the pre-set temperature is increased by 1°C, after another hour the pre-set temperature will increase by another 1°C. The temperature is kept constant for 10 hours. In Heat Mode: after 1 hour the pre-set temperature is decreased by 1°C, after another hour the pre-set temperature will decrease by another 1°C. The temperature is kept constant for 10 hours.



Timer: Use the timer button to set an ON or OFF timer. To remove either the ON or OFF timer, press the timer button until you reach '00 hrs'.

Timer on When the air conditioner is in standby mode, use the timer button to move between 1 and 24 hours in which the air conditioner will turn on.

Timer off When the air conditioner is on, use the timer button to move between 1 and 24 hours in which the air conditioner will turn off.



Fan speed button: Use the fan speed button to select either Low, Medium or High Fan Speed. This function is disabled in Dry and Sleep Mode. An LED light will indicate which mode is currently in use.



Swing button: Use the swing button to turn the automatic louvre on and off. The louvre must be left open whilst the machine is in operation – it is optional as to whether the louvre is stationary or moving.



Increase and decrease buttons: Use the increase and decrease buttons when choosing a desired temperature or setting the On or Off Timer.



Mode button: Press the mode button to scroll through the available modes: Cool, Dry, Fan and Heat. (Heat is only available on the CH models). An LED light will indicate which mode is currently in use.

Cool

The temperature can be set between 16°C and 32°C using the increase and decrease buttons. The air conditioner will run until the desired temperature is reached (the compressor will turn off, but the fan will continue to run). If the temperature in the environment increases above the target temperature, the air conditioner will automatically come back on.

Dry

The air conditioner will run according to the ambient temperatures below.

> 25°C: The compressor runs for 15 minutes and then stops for 3 minutes.

The fan will run continuously

25°C to 20°C: The compressor runs for 10 minutes and then stops for 3 minutes. The fan will run continuously

20°C to 15°C: The compressor runs for 6 minutes and then stops for 3 minutes. The fan will run continuously

< 15°C: The compressor will stop working and therefore stop drying. When the temperature reaches 17°C the unit will run as per above

The air conditioner will default to low fan speed - this cannot be changed.

Temperature cannot be selected.

Note: make sure the drainage hose is attached to the central drainage port for continuous drainage (see page 17).

Fan

The room air is circulated but not cooled. Select either High, Medium or Low.

Heat

Only available on CH models.

The temperature can be set between 16°C and 32°C using the increase and decrease buttons. The air conditioner will run until the desired temperature is reached. If the temperature in the environment drops below the target temperature, the air conditioner will automatically come back on.

Note: the compressor will stop working straight away however the fan may continue to run if the coil pipe temperature is detected to be above 34°C. The fan will stop running once the coil pipe temperature reaches 34°C or below.

The supply air fan will run continuously, blowing hot air out the front of the air conditioner. The exhaust air fan, blowing hot air out the back of the portable air conditioner, will turn on periodically as required. In certain conditions, depending on the temperature and humidity level, the exhaust air fan will run continuously. Both situations are normal operations.

Note: make sure the drainage hose is attached to the lower drainage port for continuous drainage (see page 17).

Remote Control

Before using the remote control, remove the plastic tab.
The remote control has a range of approximately 3 metres.

Automatic Defrost

At low room temperature frost may build up at the evaporator during operation. The air conditioner will automatically start defrosting and the LED above the power button will flash.

When the air conditioner operates in Cool or Dry Mode and the ambient temperature sensor senses that the evaporator coil temperature is below -1°C , the compressor will stop operating for ten minutes or until the coil temperature has reached 7°C . The air conditioner will restart in Cool Mode. This is not a fault and is part of the portable air conditioners process.

Overload Protection

In the event of a power cut, the air conditioner has a memory function and therefore will continue to run on the same setting it was set to before the power cut occurred. In order to protect the compressor, the compressor will start after a 3 minute delay.

Drainage

When the air conditioner is used in Dry Mode the drainage hose needs to be attached continuously to the central drainage port in order to remove any collected water (Diagram 1).

When the air conditioner is used in Heat Mode the drainage hose needs to be attached continuously to the lower drainage port in order to remove any collected water (Diagram 2).

When the air conditioner is used in Cool Mode the drainage hose does not need to be attached continuously. However, in high humidity conditions or after a long period of use, the water tank will need to be drained using the drainage hose. Ft (Full Tank) will appear on the display to inform you when this needs to be done (Diagram 2).

1. Unplug the air conditioner.
2. Raise the air conditioner slightly to allow water to drain out from the water tank via gravity.
3. Remove the plug from the drainage port (it is very important not to lose the drainage bung).
4. Securely attach the drainage hose to the port.
5. Place the end of the hose over a drain or bucket and ensure that the water can flow freely out of the air conditioner.
6. Do not submerge the end of the hose into the water as this will create an air lock.
7. Once the water has been drained, remove the hose and reinsert the plug.

Diagram 1

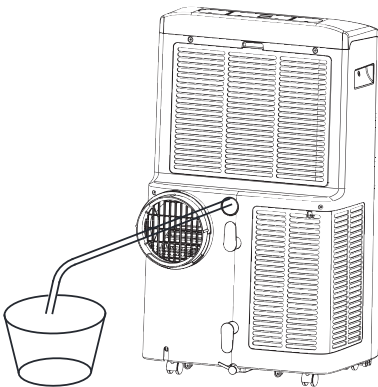
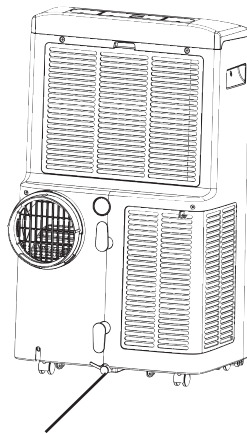

Diagram 2



Securely attach the drainage hose to the outlet.

Maintenance

To ensure your air conditioner is always performing at its best, it's important to regularly clean it.

- Always unplug your air conditioner from the mains before cleaning.
- Do not allow the air conditioner to get wet.

Cleaning the exterior

Clean the exterior with a soft, dry cloth. If the air conditioner is extremely dirty, use a slightly damp cloth. Never spray the device with water.

Cleaning the dust filter

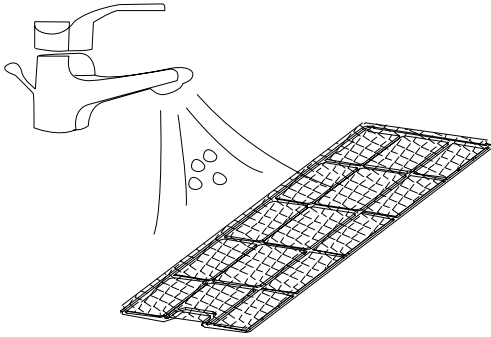

The dust filters are life-long filters and therefore should not need to be replaced (other than for wear and tear reasons). When used regularly, the filters may become clogged with dust and dirt particles. The filters must be cleaned a minimum of every two weeks (not doing so could invalidate the air conditioners' warranty). Please follow the steps below.

1. Remove the dust filters from the air conditioner (there is one at the top and one at the bottom). The dust filters are built into the filter case and cannot be removed.
 2. Clean the dust filters with the end of a Hoover or soapy water no hotter than 40°C. Rinse and dry completely before inserting back into the air conditioner.
-

Storing

If the air conditioner will not be used for a long period of time, take the following steps:

Remove the plug from the socket, detach the duct and drain the air conditioner using the drainage hose provided (see page 17).

Use the cable tidy on the back of the air conditioner to wrap the cable away.

Clean the filter (see page 18) and store the device in a dust-free location away from direct sunlight, preferably covered with a sheet of plastic.

Remember the air conditioner can also be used as an air conditioner (above 15°C) and a heater during the winter months if required.

Troubleshooting

If you come across a problem with your air conditioner, check the table below and try the suggestions. If the problem persists, contact Meaco.

Error	Action
No power to the air conditioner	<ul style="list-style-type: none">- Plug in the air conditioner- Press the power button
Air conditioner is on but the compressor is not running	The compressor does not turn on for the first 3 minutes, wait 3 minutes
Remote control does not work	<ul style="list-style-type: none">- Replace the batteries- Stand closer to the air conditioner to ensure the remote is within range
Increased noise level	<ul style="list-style-type: none">- Clean the filter (see page 18)- Make sure there is 50 cm of space around the air conditioner and that the air inlet is not blocked- Make sure the air conditioner is on a level surface
Fan speed does not change	The air conditioner is in Sleep or Dry mode, change mode if required (see page 15)
Cooling is not effective	<ul style="list-style-type: none">- Let the air conditioner run for longer- Use the air conditioner in a smaller room- Block the heat gain from the sun with blinds or curtains- Clean the filter (see page 18)- Make sure there is 50 cm of space around the air conditioner and that the air inlet is not blocked
Heating is not effective	Use the air conditioner in a smaller room
Air conditioner turns itself off	The target has been reached, either accept that the target has been reached or select a new target so that the air conditioner will run for longer

Error	Action
Air conditioner leaks water	<ul style="list-style-type: none"> - Drain water from the air conditioner before moving it (see page 17) - Straighten the drainage hose to avoid water getting trapped in any kinks or bends
Ft	Drain the excess water from the air conditioner (see page 17)
E0	Contact Meaco
E1	Contact Meaco
E2	Contact Meaco

Meaco customer care

If you have a question about your Meaco air conditioner, contact our Customer Service team who will be happy to help. Make sure you have your serial number and details of where and when you purchased your air conditioner.

Meaco contact details

Website: www.meaco.com/pages/contact-us

Email: customerservice@meaco.com

Phone: 01483 234900

Address: Meaco House, Parklands, Railton Road,
Guildford, Surrey GU2 9JX, United Kingdom

Specifications

	12,000	12,000 CH	14,000	14,000 CH	16,000	16,000 CH
Dimensions (HWD)	762 x 353 x 470 mm	762 x 353 x 470 mm	762 x 353 x 470 mm	762 x 353 x 470 mm	762 x 353 x 470 mm	762 x 353 x 470 mm
Duct diameter	15cm / 5.9	15cm / 5.9	15cm / 5.9	15cm / 5.9	15cm / 5.9	15cm / 5.9
Duct length	1.8 m / 71"	1.8 m / 71"	1.8 m / 71"	1.8 m / 71"	1.8 m / 71"	1.8 m / 71"
Drainage hose length	65 cm	65 cm	65 cm	65 cm	65 cm	65 cm
Drainage hose diameter	1.8 cm	1.8 cm	1.8 cm	1.8 cm	1.8 cm	1.8 cm
Nett weight	29.5 kg	30 kg	31 kg	31.5 kg	31.5 kg	32.1 kg
Cooling capacity	12,000 BTU	12,000 BTU	14,000 BTU	14,000 BTU	16,000 BTU	16,000 BTU
Heating capacity	-	9500 BTU	-	11,000 BTU	-	11,200 BTU
Cooling power consumption	1337 watts	1337 watts	1560 watts	1560 watts	1712 watts	1712 watts
Heating power consumption	-	1118 watts	-	1300 watts	-	1300 watts
Noise level	51 - 53 dB	51 - 53 dB	51.5 - 53.5 dB	51.5 - 53.5 dB	53 - 55 dB	53 - 55 dB
Energy rating	A	A	A	A	A	A
Max airflow	410 m3 / hour	410 m3 / hour	410 m3 / hour	410 m3 / hour	410 m3 / hour	410 m3 / hour
Moisture removal	1.6 litres / hour	1.6 litres / hour	1.8 litres / hour	1.8 litres / hour	1.8 litres / hour	1.8 litres / hour
Current (nominal)	5.9 A	5.9 A	6.9 A	6.9 A	7.5 A	7.5 A
Power supply	220-240V / 50Hz	220-240V / 50Hz	220-240V / 50Hz	220-240V / 50Hz	220-240V / 50Hz	220-240V / 50Hz
Refrigerant	R290 / 240g	R290 / 240g	R290 / 270g	R290 / 270g	R290 / 265g	R290 / 265g

Warranty Terms & Conditions

There is a two-year manufacturer's warranty on your air conditioner from the date of delivery.

Within the two-year warranty all manufacturing defects will be repaired free of charge (excluding damage to the units' filters, duct, machine adaptor, window adaptor, remote control, drainage hose, drainage bungs, flexible window kit and standard window kit which can be subject to wear and tear).

The following applies:

1. Any repair or replacement of your air conditioner or its components during the warranty period will not result in an extension of the warranty period.
2. Any repair or replacement of your air conditioner or its components during the warranty period will not result in the warranty period starting again.
3. If your air conditioner has been opened or tampered with or not genuine components have been fitted by yourself or anyone other than a Meaco engineer, your warranty is invalid.
4. Components subject to normal wear and tear, the combined dust filter and case, HEPA filter and hose adaptor are not covered by the warranty.
5. The warranty is only valid on presentation of the original, unaltered and date-stamped purchase receipt. If you are unable to produce proof of purchase, the warranty on your air conditioner is invalid.
6. The warranty does not cover damage caused by actions that deviate from those as described in the instruction manual or by neglect.
7. The warranty does not cover faults caused by dirt or by third-party products.
8. Using a third-party switching device that turns the air conditioner on or off via the mains will invalidate the warranty.
9. The warranty does not cover accidental damage.
10. All claims for compensation, including consequential damage, will not be entertained.

For the full list of the warranty terms and conditions please visit: www.meaco.com/warranty-terms.

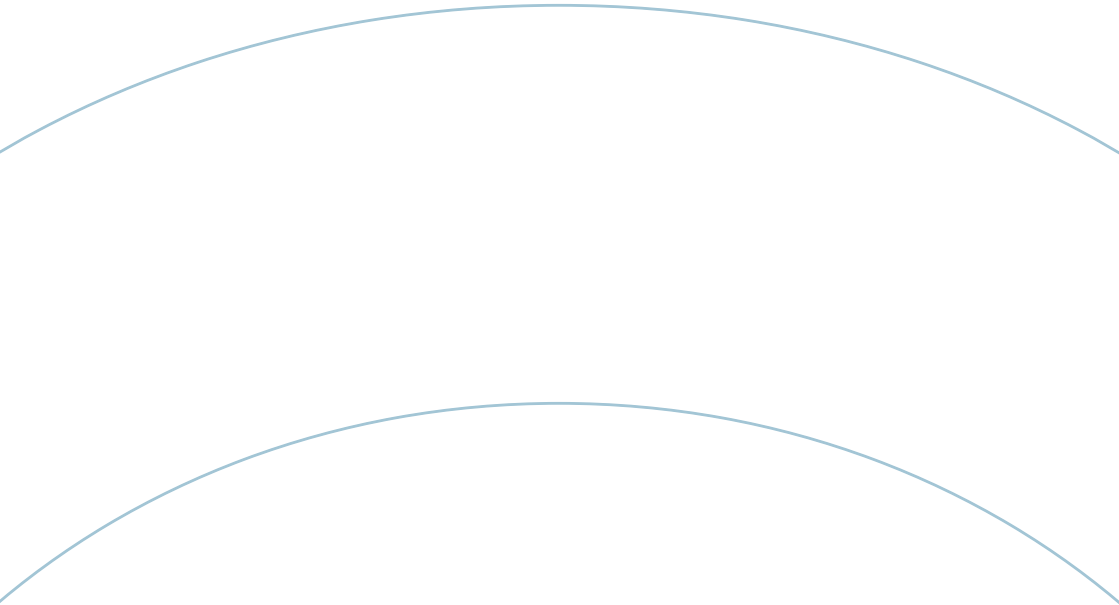

Meaco (U.K.) Limited
Meaco House, Parklands, Railton Road, Surrey GU2 9JX

meaco.com



The mark of
responsible forestry