

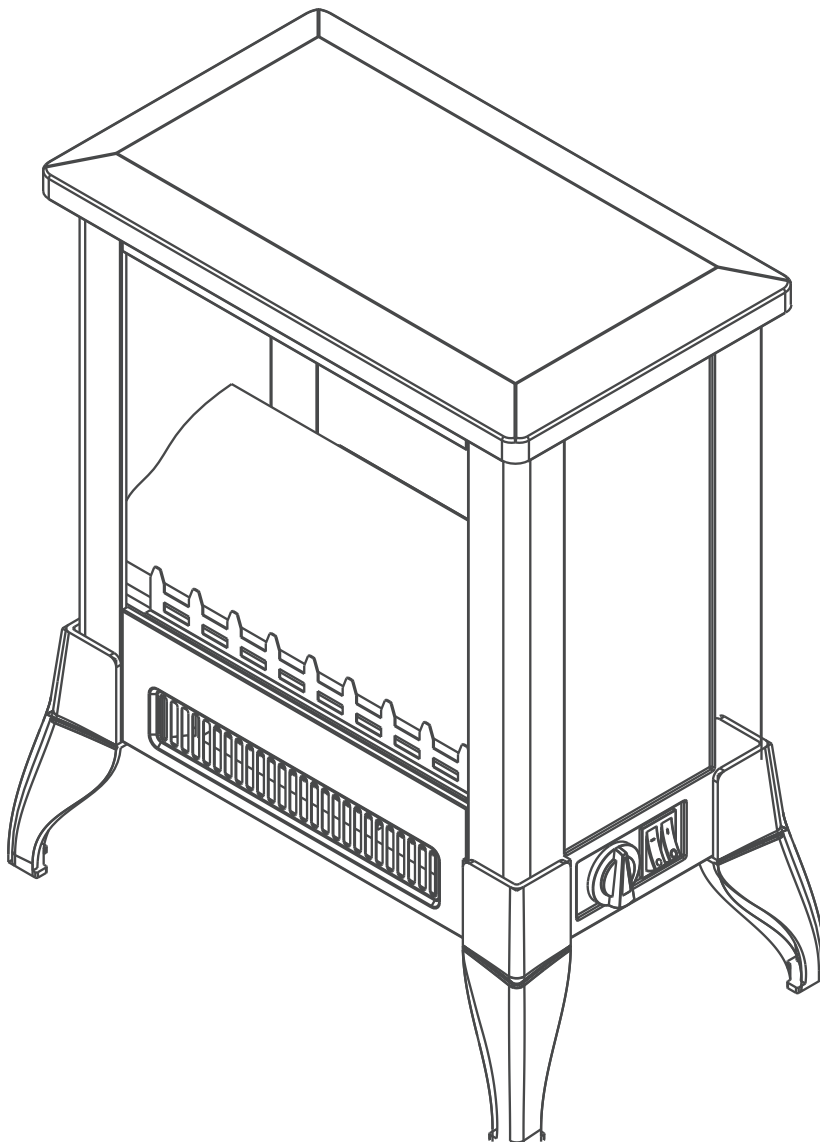

IN230200058V01_UK

820-183V71



IMPORTANT, RETAIN FOR FUTURE REFERENCE: READ CAREFULLY

ASSEMBLY & INSTRUCTION MANUAL

Table of content

Introduction

Intended use Page2
Technical specificationsPage2

Safety Instructions

Danger of death by electric shock Page3
Avoiding risk of death in the unit environmentPage4











Before operationPage5

Operating instructions.....Page6

Maintenance and cleaning

Cleaning the heater Page7

DisposalPage7

The following symbols are used in this unit operating manual:			
	Read the operating manual!		Danger of death or serious injury to toddlers and children!
	Observe the warning and safety instructions		Warning! Do not cover heater!
	Beware of electric shock! Danger of death!		Wear protective gloves!
	Risk of explosion!	W	Watts (power)
	Fire hazard!	V ~	Volts (alternating current)
	Beware of hot surfaces!		Dispose of packaging and product in an environmentally friendly manner!

ELECTRIC FIREPLACE

Introduction

 Study the page with the pictures & illustrations, become acquainted with the functions of the unit, and read the following operating and safety instructions before using the unit for the first time. Only use the unit for the prescribed purposes and in the prescribed way. Keep these instructions in a safe place. Please also hand over all documents to the recipients of the unit if/when passing it on.

Intended use

The unit is intended to generate hot air in closed, dry rooms. The electric flame simulator conveys a log fire atmosphere. Other types of use and modifications to the unit are not regarded as intended, and pose a serious danger of accidents. The manufacturer is not liable for loss or damage caused by improper use or any other use than the intended purpose. The unit is designed for domestic use only and is not suitable for commercial purposes.

Technical specifications

Nominal voltage: 220V -240V-, 50 Hz

- This appliance can be used by children aged from 8 years and above and persons with reduced physical, sensory or mental capabilities or lack of experience and knowledge if they have been given supervision or instruction concerning use of the appliance in a safe way and understand the hazards involved. Children shall not play with the appliance. Cleaning and user maintenance shall not be made by children without supervision.
- If the supply cord is damaged, it must be replaced by the manufacturer, its service agent or similarly qualified persons in order to avoid a hazard.
- **WARNING:** In order to avoid overheating, do not cover the heater.
- The heater must not be located immediately below a socket-outlet.
- **WARNING:** The heater must not be used if the glass panels are damaged.
- Do not use this heater in the immediate surroundings of a bath, a shower or a swimming pool.
- The appliance is intended to household and indoor used.
- Do not use this heater with a programmer, timer, separate remote-control system or any other device that switches the heater on automatically, since a fire risk exists if the heater is covered or positioned incorrectly.

This product is only suitable for well insulated spaces or occasional use

Safety Instructions

WARNING! Please read all safety instructions.

Failure to adhere to the safety instructions can cause electric shock, fire and/or serious injuries.



SAVE ALL SAFETY INSTRUCTIONS FOR FUTURE REFERENCE!

- This appliance can be used by children aged from 8 years and above and persons with reduced physical, sensory or mental capabilities or lack of experience and knowledge if they have been given supervision or instruction concerning use of the appliance in a safe way and understand the hazards involved.
- Children shall not play with the appliance.
- Cleaning and user maintenance shall not be made by children unless they are older than 8 years and supervised.
- Children should be supervised to ensure they do not play with the appliance.
- Children of less than 3 years should be kept away unless continuously supervised.
- Children aged from 3 years and less than 8 years shall only switch on/off the appliance provided that it has been placed or installed in its intended normal operating position and they have given supervision or instruction concerning use of the appliance in a safe way and understand the hazards involved. Children aged from 3 years and less than 8 years shall not plug in, regulate and clean the appliance or perform user maintenance.
- **CAUTION!** Some parts of this product can become very hot and cause burns. Particular attention has to be given where children and vulnerable people are present.



Danger of death by electric shock

- If the supply cord is damaged, it must be replaced by the manufacturer, its service agent or similarly qualified persons in order to avoid a hazard.
- For portable heaters: Do not use this heater in the immediate surroundings of a bath, a shower or a swimming pool.



WARNING! Do not cover!

- **ATTENTION!** Never leave the electric fireplace unattended when it is in operation, as this creates a risk of injury.



ATTENTION! FIRE HAZARD!

Please ensure that the distance between the front of the electric fireplace display and any flammable objects such as furniture, curtains or suchlike is at least 1 metre.



ATTENTION! DANGER OF BURNING!

- Please be aware that the heat-radiating surfaces of the unit can achieve temperatures exceeding 50°C. Ensure that the unit is switched off and cooled-down before you touch it.
- Avoid the power cable becoming a trip hazard - always run it away from the unit from the back.



- Wear protective gloves for all maintenance work on the unit. The edges of the electric fireplace are very sharp!
- Ensure that children and pets are not endangered by the operation of the unit.
- **ATTENTION!** Never operate the unit using an external system such as a time switch. Never connect the unit to an electrical circuit which can switch it on and off via any mechanism. Injuries as well as damage to the product could result.
- Disconnect the power supply by pulling the plug out of the power socket. Never pull on the power cable.
- Always place the unit on a flat, dry surface.
- Do not install or operate the unit in vehicles.
- Unplug the unit before moving it to a different location.
- Unplug the unit before cleaning it.
- Store the unit in a dry, dust- and vibration-free place. Avoid damage to the unit.



Avoiding risk of death in the unit environment

- **WARNING!** Please ensure that the unit is not covered with towels, curtains or similar objects, as this can lead to overheating - always pay attention to keeping the ventilation slots clear.
- Do not operate the unit in rooms in which dampness can develop or in which the unit can come in contact with water.
- Do not install the appliance immediately below a socket-outlet.
- Do not install the unit underneath a shelf.

Before operating

ATTENTION! Do not place the unit directly beneath a wall power outlet, this can lead to a risk of injury and it may damage the unit.

ATTENTION! Please be careful not to pinch the power cord, and protect it from sharp edges. Damaged power cords increase the risk of an electric shock.

For heaters without built-in thermostat: **WARNING:** This heater is not equipped with a device to control the room temperature. Do not use this heater in small rooms when they are occupied by persons not capable of leaving the room on their own, unless constant supervision is provided.

WARNING! This heater is not equipped with a device to control the room temperature. Do not use this heater in small rooms when occupied by persons not capable of leaving the room on their own, unless constant supervision is provided.

The product must be installed on a flat, dry surface, after installing the 4 legs [8] with the supplied screws [9], as follows:

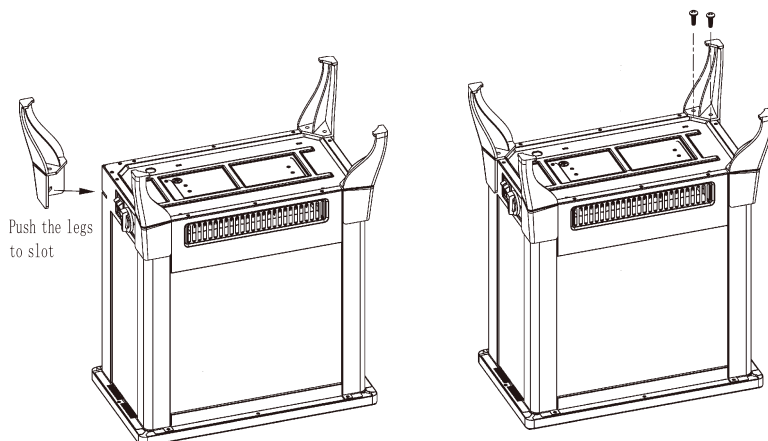

Note: Please ensure that the power plug is still accessible after installation of the electric fireplace.

Note: Ensure that the electric fireplace is correctly installed. In case of any doubt, please contact a professional.

Your electric fireplace is now ready for operation.

Operating instructions

Read All Instructions Before Use

Check that the heater outlet grill is not covered or obstructed in anyway, and make sure the power to the unit is switched on.

NOTE: When the heat function is used for the first time, a slight odor may be present. This is normal and should not occur again unless the heater is not used for an extended period of time.

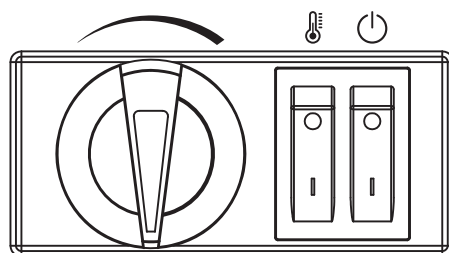

Power

The Power  Switch supplies power to all of the functions of the stove. This switch must be in the ON position for any functions to work.

Temperature Knob

Toggle the Temperature , Switch ON. Then use the Temperature Control Knob to adjust the temperature.

Cleaning

Always turn the heater OFF and unplug the power cord from the outlet before cleaning. Use a vacuum or duster to remove dust and dirt from the heater and vent areas. To maintain the finish, clean with a soft, slightly damp cloth and buff with a dry cloth. Never use abrasive cleansers, liquid sprays, or any cleaner that could scratch the surface.

Never drag the unit across a floor. The added stress from dragging the unit may cause the legs to break.

Glass Information (some models)

1. Under no circumstances should this product be operated with broken glass.
2. Do not strike or slam the glass.
3. Do not use abrasive cleaners to clean the glass.
4. This product uses tempered glass. Replacement of the glass supplied by the manufacturer should be done by a qualified service person.

Maintenance and cleaning

WARNING! DANGER OF DEATH BY ELECTRIC SHOCK! Before conducting cleaning or maintenance work please unplug the unit and let it completely cool down.

ATTENTION! DANGER OF BURNING! It is imperative to let the unit completely cool down before any work is done on it.

ATTENTION! Only an electrical technician should conduct repairs, failure to comply may lead to risk of injury and/or product damage.

ATTENTION! RISK OF INJURY! The edges of the electric fireplace are very sharp - please wear protective gloves for all maintenance work.

Cleaning the heater

- Aggressive or corrosive cleaning agents should never be used, they can cause damage to the product.
- Use a slightly damp cloth to clean the housing.
- Clean the ventilation slots regularly and thoroughly (e.g. with a vacuum cleaner) so that no dust can accumulate.
- Clean the glass plate with a damp cloth and if necessary with a glass cleaner.

Disposal



All the packaging and packaging materials consist of environmentally friendly materials. They can be disposed of as domestic waste.



Do not throw electric appliances in household waste!

The symbol above and on the product means that the product is classed as Electrical or Electronic equipment and should not be disposed with other household or commercial waste at the end of its useful life.

The Waste of Electrical and Electronic Equipment (WEEE) Directive has been put in place to recycle products using best available recovery and recycling techniques to minimise the impact on the environment, treat any hazardous substances and avoid the increasing landfill.

Information

WARNING! Only qualified specialists may repair your unit, using only original spare parts. This ensures that the safety of your unit is maintained.

WARNING! Always have the manufacturer of the unit or his/her customer service conduct the replacement of the power plug or cord [3]. This ensures that the safety of your unit is maintained.

Table for information requirements for electric local space heaters					P	
Model identifier(s): SE512-14A						
Item	Symbol	Value	Unit	Item	Unit	
Heat output				Type of heat input, for electric storage local space heaters only (select one)		
Nominal heat output	Pnom	2,0	kW	Manual heat charge control with integrated thermostat	[no]	
Minimum heat output (indicative)	Pmin	N/A	kW	Manual heat charge control with room and/or outdoor temperature feedback	[no]	
Maximum continuous heat output	Pmax	2,0	kW	Electronic heat charge control with room and/or outdoor temperature feedback	[no]	
Auxiliary electricity consumption				Fan assisted heat output		[no]
At nominal heat output	elmax	N/A	kW	Type of heat output/room temperature control (select one)		
At minimum heat output	elmin	N/A	kW	Single stage heat output and no room temperature control	[no]	
In standby mode	eISB	N/A	W	Two or more manual stages, no room temperature control	[no]	
				With mechanic thermostat room temperature control	[yes]	
				With electronic room temperature control	[no]	
				Electronic room temperature control plus day timer	[no]	
				Electronic room temperature control plus week timer	[no]	
				Other control options (multiple selections possible)		
				Room temperature control, with presence detection	[no]	
				Room temperature control, with open window detection	[no]	
				With distance control option	[no]	
				With adaptive start control	[no]	
				With working time limitation	[no]	
				With black bulb sensor	[no]	
<p>Remark:</p> <p>For electric local space heaters, the measured seasonal space heating energy efficiency η_s cannot be worse than the declared value at the nominal heat output of the unit.</p>						

If you have any questions, please contact our customer care center.

Our contact details are below:



0044-800-240-4004



enquiries@mhstar.co.uk

IMPORTER ADDRESS:
 MH STAR UK LTD
 Unit 27, Perivale Park,
 Horsenden lane South
 Perivale, UB6 7RH
 MADE IN CHINA

