

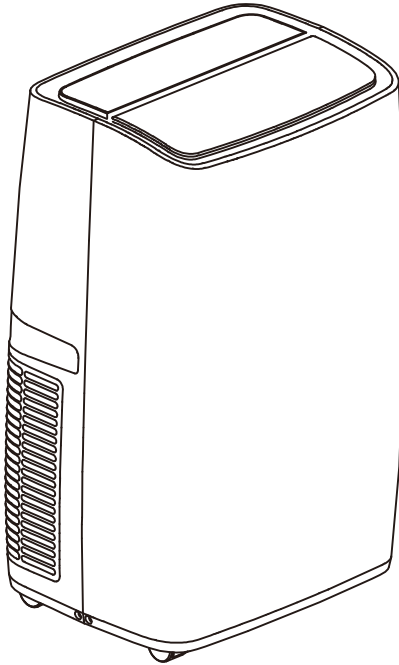

IN221200127V01_UK

823-039V70CW



Mobile air conditioner.



IMPORTANT, RETAIN FOR FUTURE REFERENCE: READ CAREFULLY

ASSEMBLY INSTRUCTION

CONTENTS

Safety-----	1
Identification of parts-----	8
Control panel Remote-----	9
controller Protection-----	11
Maintenance-----	13
Trouble shooting -----	14
Installation	
Accessories and Select the best location-----	15
Installation	
Install Exhaust Hose and Adapter-----	18
Technical Specification-----	19



Safety

Before you start:

Please read the following instructions carefully and retain for future reference.



CAUTION: FIRE, ELECTRIC SHOCK, PHYSICAL INJURY AND PROPERTY DAMAGE HAZARDS.

- When using, assembling and maintaining the air conditioner, always follow these instructions.
- Do not wet the housing or control panel.
- Do not cover the air outlet while in use.
- Do not allow children to play with the control or drop any objects into the air outlet.
- Do not place any objects or sit on top of the unit.
- Always turn off and unplug the unit when cleaning.
- Do not attempt to remove any part of the casing, unless you are an authorised technician.
- Remove the plug from the socket if the unit is not being used for long periods.
- Always connect this appliance to a 220-240 V~ mains power socket.
- Do not operate the unit with a damaged plug or loose socket.
- Do not use ways to accelerate the defrosting process or to clean, other than those recommended by the manufacturer.
- Do not store the appliance near sources of heat, such as open flames, operating gas or an electric heater.
- Do not pierce or burn. Be aware that refrigerants may not contain an odour.
- Ensure the appliance is placed, used and stored in a room with a floor area larger than 12.5m².



WARNING: KEEP VENTILATION OPENINGS CLEAR OF OBSTRUCTION.

- Servicing shall be performed only as recommended by the manufacturer.



WARNING: KEEP THE APPLIANCE IN A WELL-VENTILATED AREA, WHERE THE ROOM SIZE CORRESPONDS TO THE ROOM AREA AS SPECIFIED FOR OPERATION.

- Never use sources of ignition when searching for refrigerant leaks. Do not use a halide torch (or any other naked flame).
- For leak detection, the use of detergents containing chlorine must be avoided.
- If a leak is suspected, all naked flames shall be removed/extinguished.
- Call the service agent immediately and keep far away from the product.
- If disposal is needed, please contact the service agent or authorised personnel to do it. Do not dispose the product yourself.
- Install the appliance in accordance with national wiring regulations.
- The maximum refrigerant charge amount: 200g.
- Keep the appliance in a ventilated area. If there is a refrigerant leak, there is less likely of a explosion or fire hazard happening.
- Check cords regularly, ensuring there is no damage, wear or corrosion.
- The following leak detection methods are deemed acceptable for systems containing flammable refrigerants.
- Electronic leak detectors shall be used to detect flammable refrigerants, but the sensitivity may not be adequate or may need recalibration (detection equipment shall be calibrated in a refrigerant-free area).
- Ensure the detector is not a potential source of ignition and is suitable for the refrigerant used.
- Leak detection equipment shall be set at a percentage of the LFL of the refrigerant and shall be calibrated to the refrigerant employed and the appropriate percentage of gas (25% maximum) is confirmed.
- Leak detection fluids are suitable for use with most refrigerants, but the use of detergents containing chlorine shall be avoided as the chlorine may react with the refrigerant and corrode the copper pipe.
- If a leakage is found which requires brazing, all of the refrigerant shall be recovered from the system, or isolated (by shutting off valves).
- Oxygen free nitrogen (OFN) shall then be purged through the system both before and during the brazing process.
- Before carrying out this procedure, it is essential that the technician is completely familiar with the equipment and all its detail. It is recommended that all refrigerants are recovered safely. Prior to the task being carried out, an oil and refrigerant sample shall be taken, in case analysis is required before reusing the reclaimed refrigerant. It is essential that electrical power is available before the task is commenced.
- Become familiar with the equipment and its operation.
- Isolate system electrically.
- Before attempting the procedure, ensure that:
 - Mechanical handling equipment is available, if required, for handling refrigerant cylinders.
 - All personal protective equipment is available and being used correctly.
 - The recovery process is supervised at all times by a competent adult.
 - Recovery equipment and cylinders conform to the appropriate standards.

- Pump down refrigerant system, if possible.
- If a vacuum is not possible, make a manifold, so the refrigerant can be removed from various parts of the system.
- Make sure that cylinder is situated on the scales before recovery takes place.
- Start the recovery machine and use in accordance with manufacturer's instructions.
- Do not overfill cylinders (no more than 80% volume liquid charge).
- Do not exceed the maximum working pressure of the cylinder, even temporarily.
- When the cylinders have been filled correctly and the process completed, make sure the cylinders and the equipment are removed from site promptly and all isolation valves on the equipment are closed off.
- Recovered refrigerant shall not be charged into another refrigeration system, unless it has been cleaned and checked.
- Label all equipment, stating that it has been decommissioned and emptied of the refrigerant. The label must be dated and signed.
- Ensure there are labels on the equipment, stating it contains flammable refrigerant. When removing the refrigerant from a system, either for servicing or decommissioning, it is recommended that all refrigerants are removed safely.
- When transferring the refrigerant into cylinders, ensure that only appropriate refrigerant recovery cylinders are employed. Ensure the correct number of cylinders for holding the total system charge are available. All cylinders to be used are designated for the recovered refrigerant and labelled for that refrigerant (i.e. special cylinders for the recovery of refrigerant). Cylinders must be complete with a pressure relief valve and associated shut off valves. Empty recovery cylinders are removed and, if possible, cooled before recovery occurs.
- The recovery equipment must be in good working condition, with a set of instructions concerning the equipment that is at hand and shall be suitable for the recovery of flammable refrigerants. In addition, a set of calibrated weighing scales are available and are in good condition. Hoses shall be complete with leak-free disconnect couplings and in good condition. Before using the recovery machine, ensure it is in satisfactory working condition, has been properly maintained and that any associated electrical components are sealed to prevent ignition in the event of a leak. Consult the manufacturer if in doubt.
- The recovered refrigerant shall be returned to the refrigerant supplier in the correct recovery cylinder, and the relevant Waste Transfer Note arranged. Do not mix refrigerants in recovery units and especially not in cylinders.
- If removing compressors or compressor oils, ensure they have been evacuated to an acceptable level, so the flammable refrigerant does not remain within the lubricant. The evacuation process shall be carried out prior to returning the compressor to the suppliers. Only electric heating to the compressor body shall be employed to accelerate this process. When oil is drained from a system, it shall be carried out safely.

- Service shall only be performed as recommended by the equipment manufacturer. Maintenance and repair operations requiring the assistance of other skilled personnel shall be carried out under the supervision of the person competent in the use of flammable refrigerants.
- Any person who is involved with working on or breaking into a refrigerant circuit, should hold a current valid certificate from an industry-accredited assessment authority, which authorises their competence to handle refrigerants safely in accordance with an industry recognized assessment specification.
- Please note, this product has non-serviceable parts. The coolant gas in this appliance cannot be replaced.
- Under guided supervision, this appliance can be used by children aged eight years and above, provided they understand the potential risks and hazards. Under guided supervision, the appliance can be used by persons with disabilities or persons without experience, provided they understand the potential risks and hazards.
- Children shall not play with the appliance.
- Cleaning and user maintenance shall not be made by children without supervision.
- Ensure there is at least 31cm of space between the wall and back of the unit. Keep the unit away from curtains or drapes, so they cannot fall against the back air intake.
- If the supply cord is damaged, it must be replaced by the manufacturer, its service agent or similarly qualified persons to avoid a hazard.
- If using this appliance with an extension lead, do not exceed the maximum rated wattage.
- Do not use this appliance in bathrooms or wet environments/locations.
- Appliance must not be used in closed cupboards or changing rooms.
- Do not cover the appliance with clothing or other fabrics.
- Appliance must be kept at a suitable distance from walls, furniture and curtains to prevent overheating due to poor ventilation.
- Do not use the appliance if no one is at home. If you are away for long periods, turn off the power and remove the plug from the socket.
- The filter should be cleaned or replaced periodically to prevent insufficient air flow, caused by a build up of dust. Poor air flow will cause overheating, reduce the performance of the unit and add more hazard risks.
- This appliance is designed for **INDOOR DOMESTIC USE ONLY**.
- Do not install the appliance in a laundry room.

RECYCLING & DISPOSAL

The packaging of your new product has a recycle mark on it.



Please dispose of it as recycled paper. Waste electrical products should not be disposed of with general household waste. This is to prevent the possible harm to the environment and human wellbeing. Contact your local council or government for information, regarding the collection schemes in your area.



Identification of parts

Identification of parts

• Front

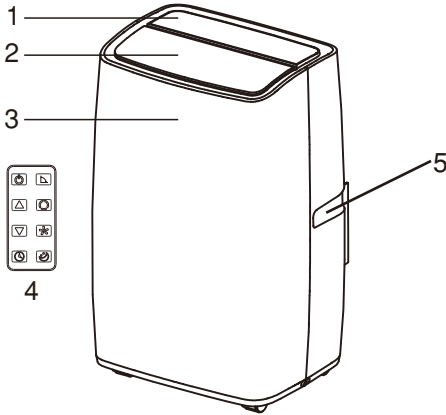

- 1 Control panel
- 2 Cold air outlet
- 3 Signal receptor
- 4 Remote controller
- 5 Transport handle
- 6 Air outlet hose
- 7 Evaporator air intake
- 8 Lower drain port
- 9 Upper drain port

• Back

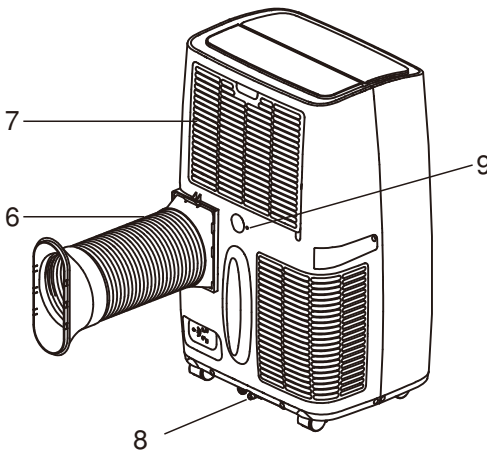

 *The figures in this manual are based on the external view of a standard model. However, the shape may differ from that of the air conditioner you have selected.*

Control Panel

This section explains how to use this appliance.

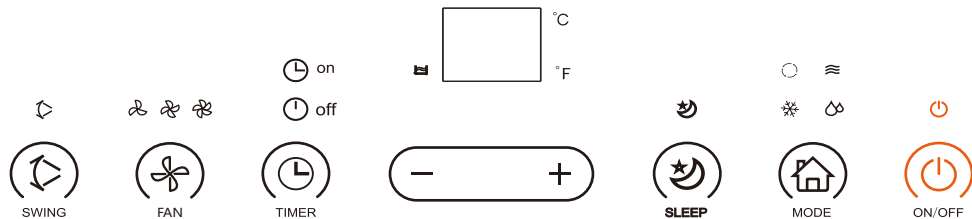

Push buttons

Power button

Speed button

Timer/ temperature up button

Timer button

Mode button

Timer/temperature down button

Sleep button

Automatic swing button

Indicators

Low fan speed

Middle fan speed

High fan speed

Automatic swing

Cool

Fan

Dehumidify

Timer on

Timer off

Automatic

Control Panel Operation

- Automatic, cool, fan and dehumidify.

1. Turn on the unit

a) Plug in - the unit beeps once.

b) Press to turn the unit on.

The LED displays the room temperature.

Press the button again to turn the unit off.

2. Select operating mode

Press - each time the mode will circle as below. When the mode indicator flashes and no button is pressed for several seconds, the operation mode will be selected.

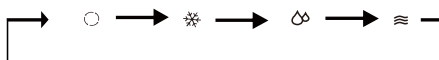

3. Adjust Temperature

When in cool mode, the temperature can be set between 15- 31 °C.

Press or once to increase or decrease the temperature by 1 °C.

The unit LED shows the target temperature for five seconds, then displays the room temperature.

To Shift the unit between Celsius and Fahrenheit, hold + and— simultaneously when the appliance is on. The corresponding indicator of °C and °F will light up.

4. Adjust Fan Speed

Press  the to select a desired fan speed, as shown below.





5. Power

When you press  again, the unit will beep and turn off.

Notice:

Each mode working principle

-  Automatic mode

1. Once the automatic operation is selected, the indoor temperature sensor detects room temperature automatically - it will select the desired operation mode  or \approx °C, the unit will automatically select mode.
2. When the room temperature $\geq 24^{\circ}\text{C}$, the unit will automatically select  mode.
3. When the room temperature $< 24^{\circ}\text{C}$, the unit will automatically select \approx mode.

-  Dehumidify mode

1. The up centrifugal fan will run at a low speed. The speed cannot be adjusted.
2. The unit adopts a constant temperature during dehumidifying mode. You cannot adjust the temperature.
3. If using the dehumidification for long periods, connect the drain hose to the unit.

-  Cool mode

1. When the room temperature is higher than set temperature, the compressor starts to run.
2. When the room temperature is lower than set temperature, the compressor stops and upper fan operates at original set speed.

- \approx Fan mode

1. The fan runs at set speed - the compressor does not run.
2. The adjustment of temperature is not effective.

-  Timer on and  Timer off function

1. Press 'Timer' while the unit is running, so the unit automatically turns off at a certain time. The icon will be lit.
2. Press 'Timer' while the unit is on standby, so the unit automatically turns on at a certain time The timer icon be lit.
3. The time can be adjusted between 1-24 hours. Press the temp up (+) or temp down (-) button to increase or decrease the time one hour.

- (☺) Sleep mode

1. The ☺ operation is effective when the unit is under ❄ mode.

2. Press the ☺ button in ❄ mode, then the unit will work under sleep mode and the up centrifugal fan will turn to the low speed automatically (the speed icon light remains on the previous setting). The set temperature will increase by 1°C after one hour, then increase by 2°C after two hours. After six hours the unit will stop running.

3. Child lock

Press and hold (☺) for a few seconds – the display will show 'LC' and the child lock function will be activated. Press and hold the button for a few seconds again to cancel the child lock function.

- (↻) Automatic swing







1. When the swing button is activated, the blade goes up and down automatically. If you want to stop, press the button again.

Except the 'AUTO' mode, the appliance has memory function: When the appliance is turned on, it will return to the last mode used.

Remote controller

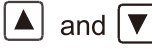
Remote controller

The remote controller transmits signals to the system.

- 1  **BUTTON**
Press this button to select the operation mode.
- 2  **BUTTON**
Press this button to turn on/off the appliance.
- 3  **BUTTON**
Press to select fan speed.
- 4 5  **SETTING BUTTONS**
Press to adjust room temperature and timer.
- 6  **BUTTON**
Press to cancel mode operation.
- 7  **BUTTON**
Press to set a timer, so the unit turns on/off automatically.
- 8  **BUTTON**
Used for automatic swing set.

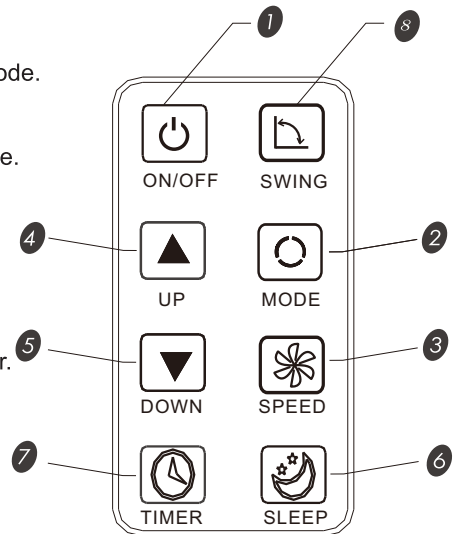

Remote controller

Remote controller

■ How to install batteries

● Inserting batteries

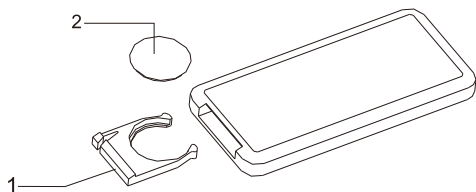

Slide the cover to open. Be sure the direction is correct.

1. Open the back cover and take off the isolating film on the batteries.
2. Put the batteries inside the slot, with anode and cathode in the right directions.
3. Put on the back cover.

Note:

- 1) The anode and cathode of the batteries must be corresponding to the signs of '+' and '-' on the remote control.
- 2) Do not mix new and old batteries.
- 3) If not using for long periods, take out the batteries.
- 4) To prevent environmental pollution, take out the used batteries and dispose safely and appropriately.

● How to Use

To operate the air conditioner, aim the remote controller at the signal receptor. The remote controller will operate the air conditioner at a distance of up to 5m (16.4 feet) when pointing at the signal receptor.

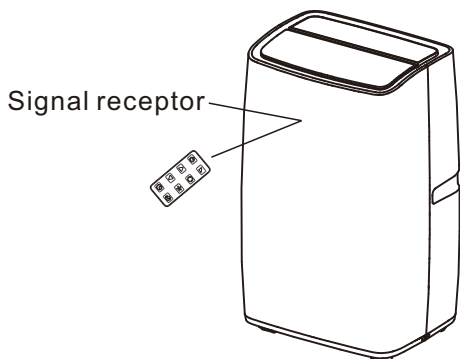

Protection

Operating condition

The protective device may trip and stop the appliance in the cases listed below.

Cooling	Indoor air temperature is over 43°C
	Room temperature is below 15°C
Dehumidifying	Room temperature is below 15°C

If the unit is on COOLING or DRY mode, and a window or door is open, whilst the relative humidity is above 80%, dew may drip down from the unit.

Features of protector

- 1 The protective device will work in the following cases:
 - Restarting the unit straight after it stops or changing the mode during operation. You need to wait for three minutes.
- 2 • If the unit has been unplugged, it will return to the original mode when restarted. The timer must be set again.

Drain water

Special reminder: There is condensing water within this unit. The water is partly kept between the condenser and water plate.

When the water level rises to the upper level, the float switch and water full indicator (E4) lights on - this is a reminder to drain the water. Please cut off the power supply, move the appliance to a suitable place, remove the drain plug and drain water completely. Once drained, reinstall the plug or the appliance may leak and make your floor wet.

If the appliance is placed in a position admitting drain water, you also can connect the drain hose to the drain port to drain water.

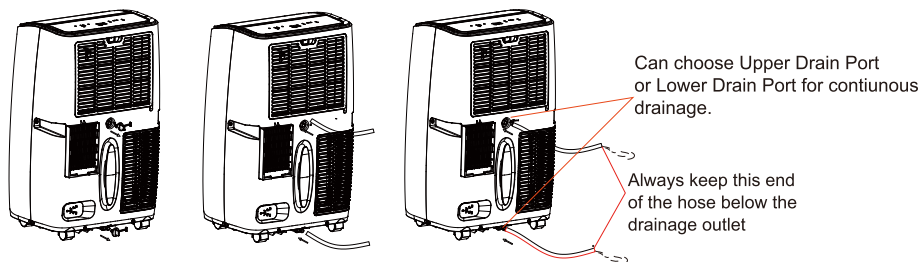

Maintenance

Appliance maintenance

1 Cut off the power supply

Turn off the appliance first before disconnecting from power supply.



2 Wipe with a soft and dry cloth.

Use lukewarm water (below 40°C (104°F)) to clean if the appliance is very dirty.



Use a dry and soft cloth to clean it.

3 Never use volatile substance such as gasoline or polishing powder to clean the appliance.



4 Never sprinkle water onto the main unit



Dangerous!
Electric shock!

Air filter maintenance

It is necessary to clean the air filter after using it for about 100 hours.

Clean it as follows:

1 Stop the appliance and remove the air filter.

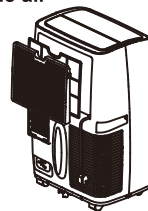

2 Clean and reinstall the air filter.

If the dirt is conspicuous, wash it with detergent in lukewarm water. After cleaning, dry it in a shaded and cool place, then reinstall it.

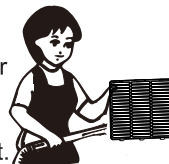



- ### 3
- ☑ *Clean the air filter every two weeks if the air conditioner operates in an extremely dusty environment.*

Maintenance after using

1. If the appliance is not being used for long periods, pull out the primary and secondary rubber plug from the port, so the water can drain.
2. Keep the appliance running with the fan for half a day, so the inside can dry and prevent mould.
3. Stop and unplug the appliance, then take out the batteries of the remote control. Store the appliance properly.
4. Clean the filter and reinstall it.
5. Remove the air hoses and store them properly. Ensure the hole is covered tightly.

Troubleshooting

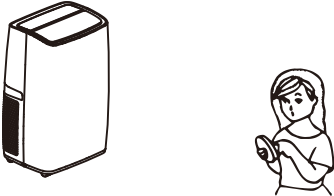
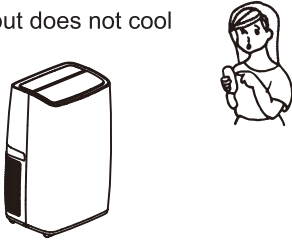
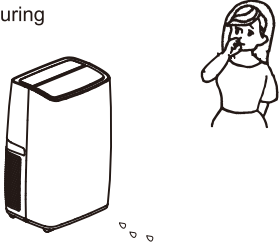
The following cases may not always be a malfunction, please check suggestions below before asking for service.

Trouble	Analysis
<p>Does not run</p> 	<ul style="list-style-type: none"> - The protector trip or fuse has blown. - Wait for three minutes and start again - the protector device may prevent the unit from working. - Batteries in remote control could be dead and need replacing. - Plug is not properly plugged in.
<p>Runs for a short while only</p> 	<ul style="list-style-type: none"> • If the set temperature is close to room temperature, you can lower the set temperature. • Air outlet is being blocked. Remove items that are blocking the air outlet.
<p>It works but does not cool</p> 	<ul style="list-style-type: none"> - The door or window is open. - There is another heated appliance, such as a heater or lamp. - Air filter is dirty and needs cleaning. - Air outlet or intake is blocked. Set temperature is too high.
<p>Water leak during moving</p> 	<ul style="list-style-type: none"> - Drain the water before moving. - To avoid leaks, place the unit on a flat ground.
<p>Does not run. The water full indicator 'E4' shows.</p> 	<ul style="list-style-type: none"> • Pull out the rubber plug to drain water. - If it remains in this state, please contact the manufacturer, its service agent or a similarly qualified professional.

Troubleshooting

Before claiming repair, check the machine as follows:

Failures	Causes	Solutions
Machine fails to start up.	Power supply failure: 1. Not plugged in. 2. Plug or socket is damaged. 3. Fuse is damaged. .	1. Plug in the appliance. 2. Replace the power cord or socket. 3. Replace the fuse using a service provider (Specification: 3.15A/250VAC).
Machine automatically stops.	The timer is up or the set temperature is reached.	Restart or wait for the auto-switch.
No cold air under COOLING mode.	1. Room temperature is lower than set temperature. 2. Machine enters into anti-frost protection.	1. This is normal. The machine will automatically switch while the room temperature is higher than the set temperature; 2. The machine will automatically switch after anti-frost protection is over.
LED displays failure code 'E2'	Room temperature sensor has failed or is damaged.	Replace the room temperature sensor.
LED displays failure code 'E3'	The evaporator oil pipe sensor has failed or is damaged.	Replace the evaporator coil pipe sensor.
LED displays failure code "E4"	Water full warning.	Drain the water.

Installation

Installation accessories

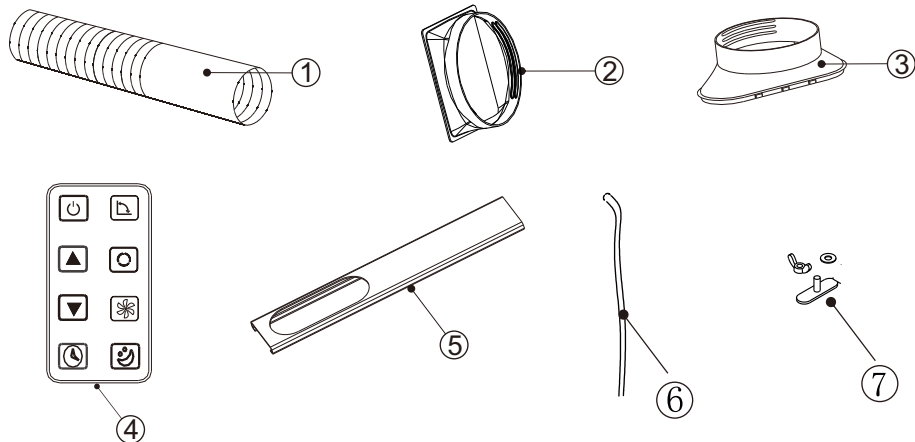

- | | |
|--------------------------|---------------------------------|
| ① Air exhaust duct | ② Connector of air exhaust duct |
| ③ Window exhaust adapter | ④ Remote control |
| ⑤ Baffle Plate | ⑥ Drain Pipe |
| ⑦ Wing nut set | |

Select the best location

- Beside a window or door.
- There must be at least 60 cm of space between all sides of the unit and the wall.
- Fix one end of the air hose to the air outlet, which is on the underside of the appliance.
- Extend the air hose, ensuring the other end of the air hose has space between the window, door or any other opening.
- Do not block the air outlet or intake.

Install Exhaust Hose and Adapter

How to connect the connectors to the Air exhaust duct

1. Extend the air exhaust duct by drawing out the two ends of the duct.



2. Screw the air exhaust duct into its connector.

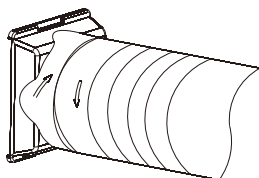

3. Screw the connector of window into the plastic connector.

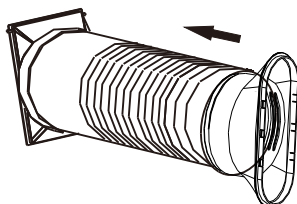

4. Place the connector of the air exhaust duct onto the unit.

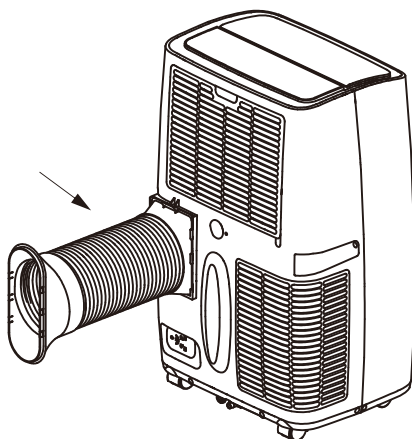

Install Window Kit

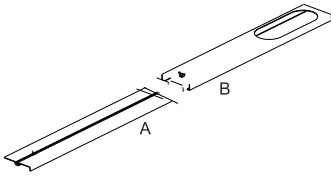
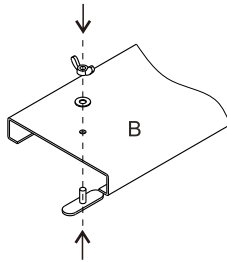

Fig. 1

1. Separate both boards A board, and B board



2. Screw the wing nut through the B board. Leave 2/3 mm of free space.

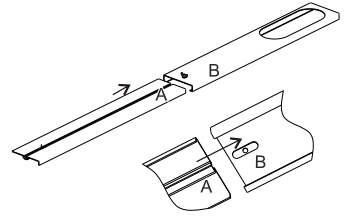

Fig. 2

3. Insert A board into B board according to arrowhead direction.

4. Assembly finished, you can adjust A board up or down, according to height of the window. Screw it unit it is tight.



Fig. 3

5. Install exhaust air duct & its accessories into window kit according to arrowhead direction.

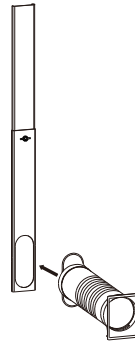

Fig. 4

6. Assembly finished.

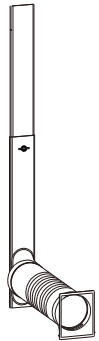

Fig. 5

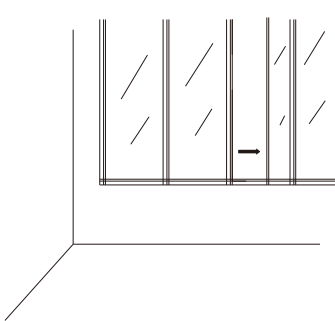

Fig. 6

7. Open the window where need install exhaust air duct, window kit and their accessories.

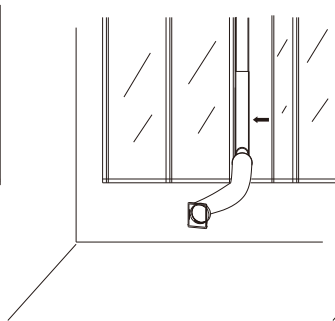

Fig. 7

8. Install exhaust air duct, window kit and their accessories onto window, then close the window according to arrowhead direction in Fig7 drawing to press window kit tightly.

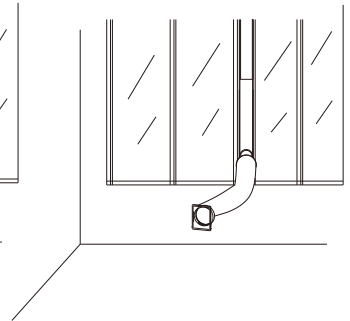

Fig. 8

9. Install exhaust air duct, window kit and their accessories onto window according to Fig8 drawing illustrated.

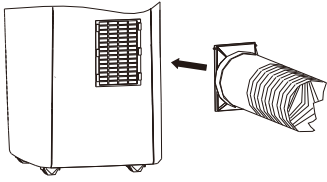

Fig. 9

10. Connect another end of exhaust air duct and its accessories onto portable air conditioner.

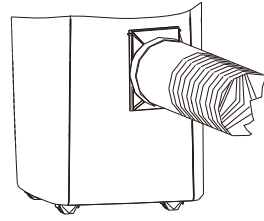

Fig. 10

11. Exhaust air duct & its accessories assembly finished as Fig10 drawing illustrated.

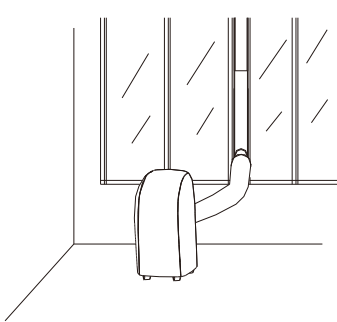

Fig. 11

12. Whole unit assembly well as Fig11 drawing illustrated.

Technical specifications

Model		823-039V70CW(FDP35-3031ZPR5)
Cooling Capacity		3500W
Cooling Input Power/Current		1300W/6.0A
Air Flow Volume (m ³ /h)		400m ³ /h
Rated Voltage/Frequency (V/Hz)		220-240V~/50Hz
Sound Pressure Level (dB (A))		L _m : 54dB(A)
		L _{WA} : 65dB(A)
Rated Energy Efficiency Ratio(EER _{rated})		2.6
Global Warming Potential (kg C ₂ O)		3
EER _{rated} Class		A
Net Weight (Kg)		29.0kg
Dimensions WXDXH	Body (mm)	L44*D33.5*H66.5cm
	Package (mm)	468X378X870mm
Refrigerant		R290
Applying Space(m ²)		18~23m ²
Miniature Fuse		3.15A 250VAC

If you have any questions, please contact our customer care center.

Our contact details are below:



0044-800-240-4004



enquiries@mhstar.co.uk

IMPORTER ADDRESS:

MH STAR UK LTD

Unit 27, Perivale Park,

Horsenden lane South

Perivale, UB6 7RH

MADE IN CHINA

