



IN240600277V01_UK

820-421V71_820-421V73



Panel Heater

This product is only suitable for well insulated spaces or occasional use



EN_IMPORTANT, RETAIN FOR FUTURE REFERENCE: READ CAREFULLY.

**FR_IMPORTANT: A LIRE ATTENTIVEMENT ET À CONSERVER POUR CONSULTATION
ULTÉRIEURE.**

ES_IMPORTANTE, LEA Y GUARDE PARA FUTURAS REFERENCIAS.

PT_IMPORTANTE, RETER PARA REFERÊNCIA FUTURA: LEIA ATENTAMENTE.

DE_WICHTIG! SORGFÄLTIG LESEN UND FÜR SPÄTERES NACHSCHLAGEN AUFBEWAHREN.

**IT_IMPORTANTE! CONSERVARE IL PRESENTE MANUALE PER FUTURO RIFERIMENTO E
LEggerlo ATTENTAMENTE.**

IMPORTANT SAFEGUARDS

When using an electrical appliance, basic safety precautions should always be observed, including the following:

READ ALL INSTRUCTIONS BEFORE USING

WARNING: To reduce the risk of fire, electrical shock, or injury to person:

1. The product is for household use only.
2. Connect the appliance to single-phase AC supply of the voltage specified on the rating plate.
3. In order to avoid overheating do not cover the heater.
4. Never leave the heater unattended while it is in use. Always turn the product to the OFF position and unplug it from the electrical outlet when not in use.
5. Extreme caution is necessary when any heater is used by or near children, invalids or elderly person and whenever the heater is left operating and unattended.
6. The heater must not be located immediately below an electrical Socket-outlet.
7. Do not run cord under carpeting and do not cover cord with throw rugs, runners or the like. Arrange cord away from traffic area and where it will not be tripped over.
8. Do not operate the heater with a damaged cord or plug, or after the heater malfunctions, has been dropped, or damaged in any manner.
9. If the supply cord is damaged, it must be replaced by the manufacturer, its service agent or a similarly qualified person in order to avoid a hazard.
10. Avoid the use of an extension cord as this may overheat and cause a risk of fire.
11. Use the heater in a well-ventilated area. Do not insert or allow objects to enter any ventilation or exhaust opening. To prevent a possible fire, do not block air intakes or exhaust openings in any manner. Do not use on soft surfaces, like a bed, where openings may become blocked. Use the heater on flat, dry surfaces only.
12. Do not place this heater near flammable materials, surfaces or substances, as there may be a risk of fire. Keep the above flammable materials, surfaces or substances at least 1m from the front of the product and keep them away from the sides and rear.
13. Do not use the heater in any areas where petrol, paint or other flammable liquids are stored e.g. Garages or workshops as a hot, arcing or sparking parts inside the heater.
14. Don't use this heater in the immediate surroundings of a bath, a shower or a swimming pool with floor standing mode. Never locate the heater where it may fall into bathtub or other water container.
15. Never touch the heater with wet hand. The heater should be installed so that can not be touched by a person using a bath or shower.
16. This heater is hot when in use. To avoid burns and personal injury, do not let bare skin touch hot surfaces.
17. Before moving the heater, please must unplugged it and let it cool down for 15 minutes. If provided, use handles when moving the product.
18. Be sure that no other appliances are in use on the same electrical circuit as your product as an overload can occur.
19. This appliance is not intended for use by persons (including children) with reduced physical, sensory or mental capabilities, or lack of experience and knowledge, unless they have been given supervision or instruction concerning use of the appliance by a person responsible for their safety.
20. Children should be supervised to ensure that they do not play with the appliance.

FOR HOUSEHOLD USE ONLY SAVE THESE INSTRUCTIONS

STORE THIS INSTRUCTION MANUAL FOR FUTURE USE!

NEVER TOUCH YOUR PANEL HEATER OR ITS CASING WITH WET HANDS!

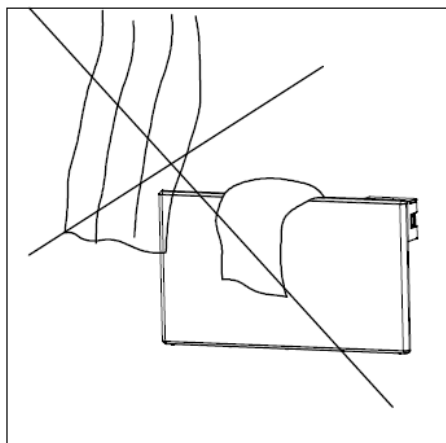
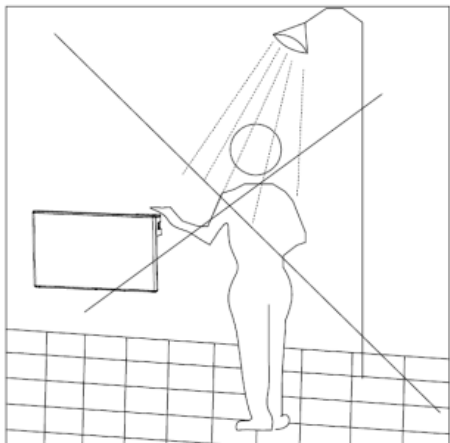

Specifications

Model	Thermostat	Voltage	Power	IP rating
NDFL1202EH-3E	Electronic	~230 V / 50 Hz	1500W	IPx4
NDFL1202EH-4E	Electronic	~230 V / 50 Hz	2000W	IPx4

Assembly

For wall mounted

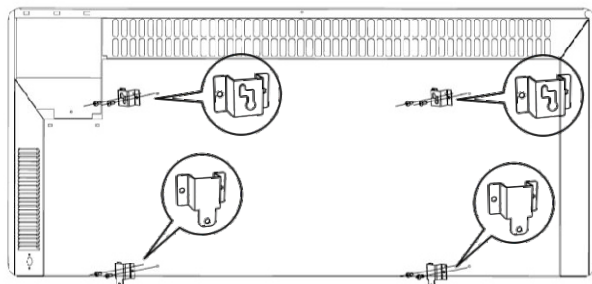

(1)



(2)

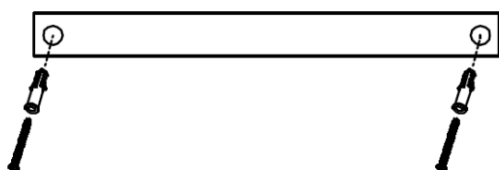

(3)

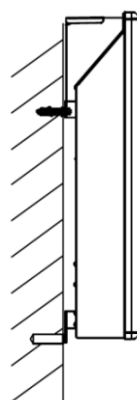

(4)

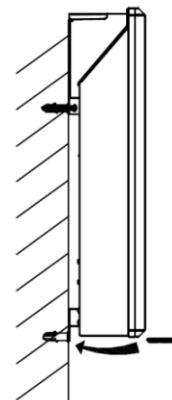

(5)

Parts list							
NO.	Description	Quantity	Note	NO.	Description	Quantity	Note
1	Screw(ST4*10)	8	Used for Wall mounted	5	Screw(ST4*14)	8	Used for Stand
2	Drill dimension paper	1	Used for Wall mounted	6	foot	2	Used for Stand
3	Plastic expansion tube	4	Used for Wall mounted	7	Instruction Manual	1	/
4	Expansion screw(ST4*40)	4	Used for Wall mounted	8	Remote	1	/

1. Fasten 4pcs hook racks with 8pcs screws(ST4*10) as picture (1).
2. Be sure to keep the distance between the heater and floor, wall and so on at least 30cm as picture (2).
3. Use drill dimension paper to drill top two holes($\Phi 8$) on the wall and put the plastic expansion tube in the holes then fasten the expansion screws(ST4*40) in the holes as picture (3).
4. Hang the top two hook racks on the expansion screws (ST4*40) as picture (4). Mark the two bottom hook racks' position on the wall and take away the heater, then drill bottom two holes($\Phi 8$) on the wall and put the plastic expansion tube in the holes as picture (4).
5. Hang the heater on the wall and put the expansion screws (ST4*40) in the bottom two holes as picture (5).

For Stand

- 1 – Fit the foot onto the bottom of the body.
- 2 – Fasten 2pcs foots with 8 screws (ST4*14).

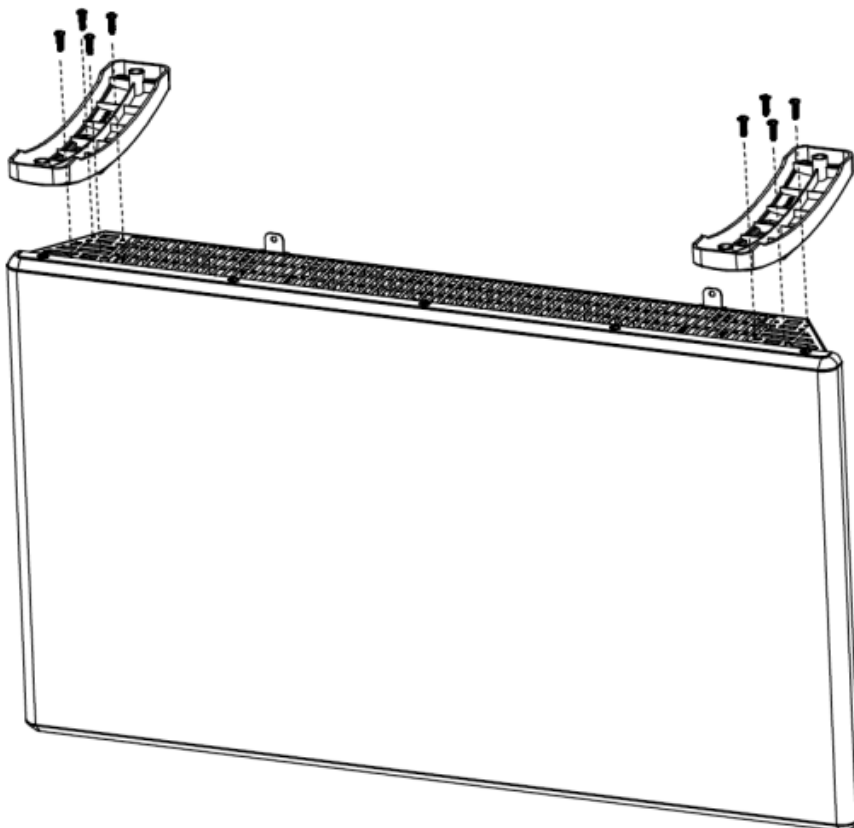



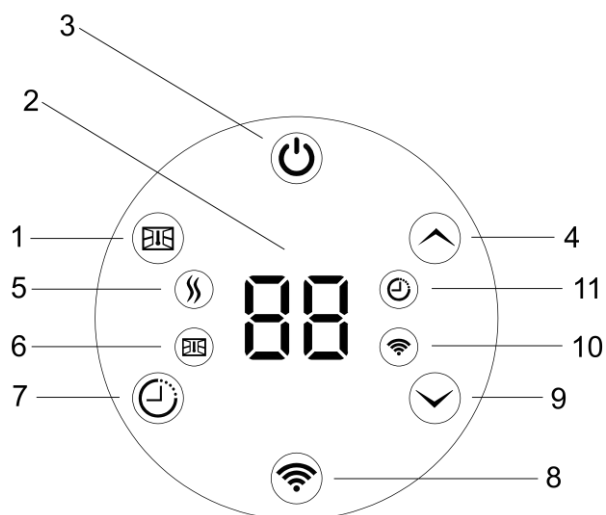



Operating instruction



Control panel



Remote controller

- 1,  Open window function button
- 2, Display (shows the desired room temperature by default)
- 3,  Power button
- 4,  Control button (+) (increase temperature/Increase timer)
- 5, Heating indicator light
- 6, Open window function mode indicator light
- 7,  Timer function button
- 8,  Wi-fi mode setting button
- 9,  Control button (-) (reduce temperature/Decrease timer)
- 10, Wi-fi program indicator light
- 11, Timer indicator light



Warning: Before the heater is turned on, it must be attached to a wall or stand. If the heater is not installed correctly or is installed askew, this may cause the heater to malfunction or in the worst case, be damaged.



If the temperature sensor is not functioning properly, you will see the symbol below on the display. Please contact the dealer or importer.

Operation

1. Turn on:

Plug in the heater. After “BI” voice, the heater enter into standby mode and show  icon on display. Press  button to turn on the heater, and display show the desired temperature.

Factory default state:

Free mode, temperature setting 22°C

Open window function: Off

Timer: Off

2. Wi-Fi connection

This APP is supported only on 2.4GHz Wi-Fi channels. Please ensure your phone is 2.4GHz capable. Please ensure your phone is connected to Wi-Fi before using.

Note this device will only work within your home Wi-Fi system.

This does not operate on 3G or 4G internet connections.

You will need a connection to your home Wi-Fi.

1) Use “Tuya Smart” APP or Smart Life APP for iOS and Android. Search and download “Tuya Smart” APP or “Smart Life” APP from Apple store or Google play. Or scan the QR code below to download “Tuya Smart” APP or “Smart Life” APP.



Tuya Smart APP



Smart Life APP

2) please make sure the heater is close to the router and your phone. Once downloaded the APP to your phone, open the APP. Then turn the heater on and press the Wi-Fi button. The Wi-Fi indicator will begin to flash. Then Press “+” as picture (1) in the APP. Then press “Add Device” as picture (2). And phone will search for nearby devices automatically. Once phone find the devices, press “Add” as picture (3). Then choose Wi-Fi channel and enter password, ensure the device and your phone are connected to the same Wi-Fi channel. Then press “Next” as picture (4). Once the device added successfully, press “Done” as picture (5).

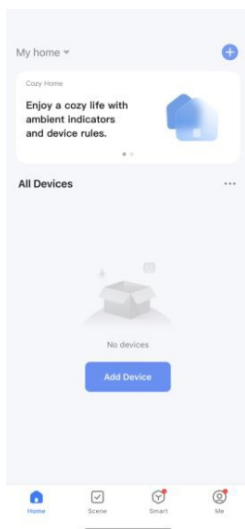

(1)

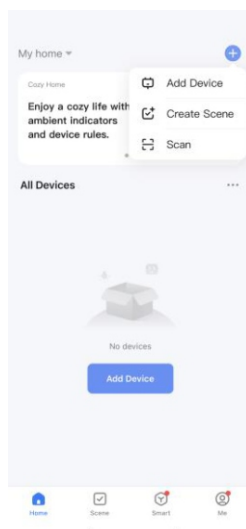

(2)

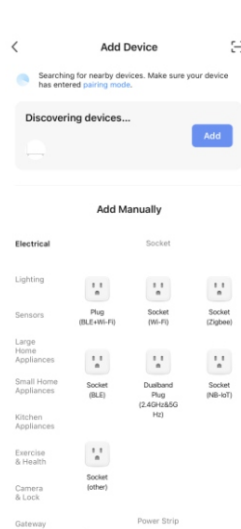

(3)

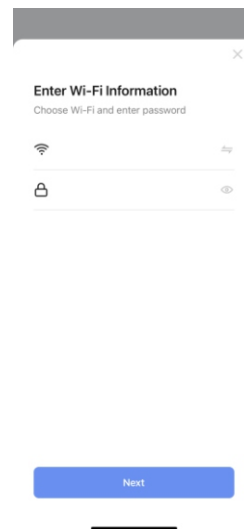

(4)

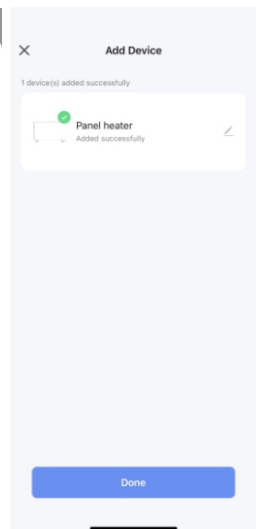

(5)

3) By connecting your heater with the iOS/Android device you can do the following:

- Set on/Stand by
- Set comfort, ECO, anti-freeze mode
- Set temperature of Comfort/ECO mode
- Set timer
- Set open window function on/off
- Set weekly programs
- Set temperature calibration
- Set group(put heaters in one zone)
- Share the heater to other people



3.Delete Wi-Fi:

If the heater is connected to Wi-Fi, press and hold Wi-Fi button for 3 seconds to delete Wi-Fi.

4.Heating mode

Temperature set 5 ~35°C by pressing  or  button.



5.Timer

Press  , then press  or  button to set timer from 0 to 24 hours.
In any modes, if set timer, when time is up, the heater will turn off.

6.Open window function

The heater has an open window function.

Default setting of open window function is closed.



After you turn on the heater, press  button, display show **FO** , then press  button to set open window function on, display show **ON** , and press  button to set open window function off, display show **OF** then press  button to save setting, or wait 10 seconds to save automatically.

Open window function description:

If you open a window widely in the space where the heater is located and the temperature drop 2 °C or more than 2 °C in two minutes, a sensor will detect the sharp drop in temperature. The heater will switch out automatically and show **FO** in display.

The heater will come back to the previous mode after 10 minutes. However you can manually restart the heater by pressing  button, and the heater will come back to the previous mode. The icon **FO** disappears on display.

7.Resetting the heater to factory default

Turn on the heater, then press and hold both  and  buttons at the same time within 3 seconds after the screen is bright.

8.Maintenance

- 1) For cleaning, always unplug the heater and leave it to cool.
- 2) Wipe the heater regularly with a damp cloth and dry the surface before turning on the heater again.
- 3) The heater must be cleaned at least once a month during the heating season.
CAUTION! The heater should never be immersed in water.
Avoid using detergents to clean the heater.

Never let any water get inside the heater; this can be hazardous.

- 4) Dust etc. should be removed with a soft cloth.

5) The heater can be stored in a dry and clean place.

9.Warranty

The warranty is valid for 2 years. The heater will be repaired or replaced during this time should any malfunction occur. The warranty applies if the heater is used according to these instructions and the customer can present a purchase receipt. If the heater malfunctions in any way, please contact the store where it was purchased or the importer.

10.Waste disposal



The symbol indicates that this product is not to be disposed of together with household waste. This product must be delivered to a recycling service or container for electrical appliances and electronic equipment. This is done to avoid health risks and prevent harm to the environment. Local businesses (or the environmental station in your neighborhood) are required by law to accept and recycle such products, as a means of environmentally sound disposal.

If you have any questions, please contact our customer care center.

Our contact details are below:

 0044-800-240-4004

 enquiries@mhstar.co.uk

IMPORTER ADDRESS:
MH STAR UK LTD
Unit 27, Perivale Park,
Horsenden lane South
Perivale, UB6 7RH
MADE IN CHINA